

Triathlon® Knee System

Surgical Protocol



**Posterior Stabilized
& Cruciate Retaining**

Triathlon® Knee System

Surgical Protocol

Table of Contents

Acknowledgments	1
Introduction	1
System Highlights	2
Assembly Instructions	6
Exposure	17
Femoral Preparation	17
Femoral Intramedullary Alignment	17
Distal Femoral Resection	21
Femoral Sizing	23
Femoral Anterior, Posterior, and Chamfer Resections	25
PS Box Preparation	29
Femoral Trial Assessment	32
Tibial Preparation	34
Option 1 - Extramedullary Referencing	35
Flexion/Extension Alignment	35
Rotational Alignment	35
Varus/Valgus Alignment	35
Tibial Slope Adjustment	35
Option 2 - Intramedullary Referencing	36
Rotational Alignment	37
Varus/Valgus Alignment	37
Establish Tibial Resection Level	38
Tibial Resection	39
Flexion and Extension Gaps	39
Tibial Component Sizing	40
Tibial Trial Assessment	41
Tibial Keel Punching	43
Patella Preparation	45
Option 1 - Bone Removing Method	45
Option 2 - Bone Remaining Method	46
Patella Trial Assessment	48
Component Implantation	49
PS or CR Femoral Component - Cemented	49
Primary Tibial Baseplate - Cemented	50
PS or CR Tibial Insert	51
Symmetric or Asymmetric Patella	51
Closure	52
Catalog	53



Triathlon® Knee System

Surgical Protocol

Acknowledgments

Stryker® Orthopaedics wishes to thank the global Triathlon® Knee System Surgeon Panel for their dedication to the development of the Triathlon® Knee System.

Introduction

The Triathlon® Knee System Instrumentation has been developed based on Stryker's 30-year orthopaedic history. The system combines the expertise of orthopaedic and human factors engineers with that of surgeons and OR staff worldwide. The Triathlon® Knee System Instrumentation provides OR **efficiency** and intra-operative **flexibility** through **Orthonomic™** designs.

Orthonomic™ Features: Incorporation of ergonomic principles into the design of orthopaedic instruments



Efficiency

The Triathlon® Knee System Instrumentation design team focused on identifying ways to increase the accuracy and simplicity of the surgical procedure, which are two variables that may affect OR efficiency. The features incorporated include:

- ▶ Open design cutting blocks to enhance visualization,
- ▶ Bold markings and color coding for ease of use and clear identification,
- ▶ Quick attach and release mechanisms to facilitate easy assembly,
- ▶ A logically organized tray layout based on the operational sequence for a streamlined process.

Flexibility

The proprietary instrumentation design also delivers intra-operative flexibility. The following features help surgeons adapt to multiple surgical realities and surgical preferences:

- ▶ Modular cutting captures, handles and cases facilitate customized surgical flow,
- ▶ A common platform that allows for seamless transition through the indications continuum,
- ▶ Navigation ready,
- ▶ Minimal incision capability.

Orthonomic™ Design

The Triathlon® Knee System Instrumentation is designed to become the new gold standard in the industry. Advanced design principles incorporating Orthonomic™ features include:

- ▶ Ergonomic soft grip handles for optimized surgeon hand fit and comfort,
- ▶ Instrument surface enhancements for reduced glare,
- ▶ Procedural enhancing mechanisms,
- ▶ Lightweight trays for ease of handling.

Triathlon® Knee System

Surgical Protocol

System Highlights



1 Femoral Alignment & Distal Resection



2 Femoral Sizing



3 Femoral Bone Resections



4 PS Box Preparation



5A Tibial EM Alignment & Resection



5B Tibial IM Alignment & Resection

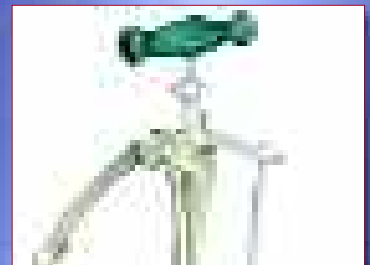

6 Tibial Sizing

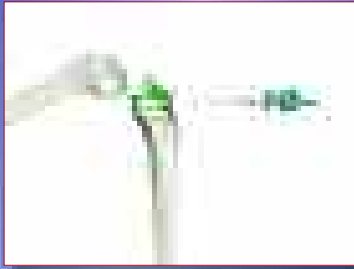

7 Tibial Keel Preparation

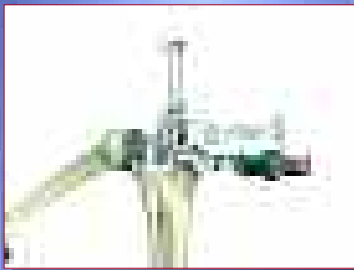

8A Patella Resection - Bone Removing Method



8B Patella Resection - Bone Remaining Method



9 Trialing

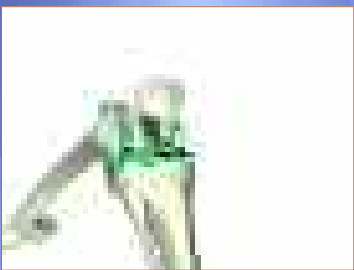

10 Component Implantation

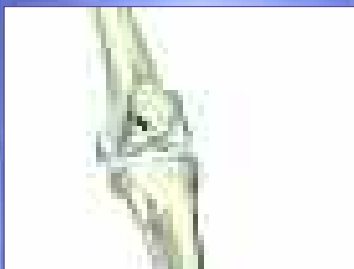

Triathlon® Knee System

Surgical Protocol



System Highlights

A Triathlon® Knee System Instrumentation Highlights pullout has been included. This can be torn out and used as a quick reference wall chart in the OR to aid both the surgeon and the OR staff.

Assembly Instructions

Many of the Triathlon® Knee System Instruments have unique mechanisms incorporated to assist surgeons and OR staff, in a simplified, efficient surgical experience. Therefore, assembly instructions have been included in the first section of this surgical technique to assist with instruments that may be pre-assembled on the back table, as well as other instruments that need to be assembled.

All of the mechanisms that allow instruments to be adjusted and/or assembled have been color-coded. Those that correspond to femoral preparation are black, those for tibial preparation are bronze and those for patella preparation are gold.



The surgical technique can be found in the next section beginning on page 17.

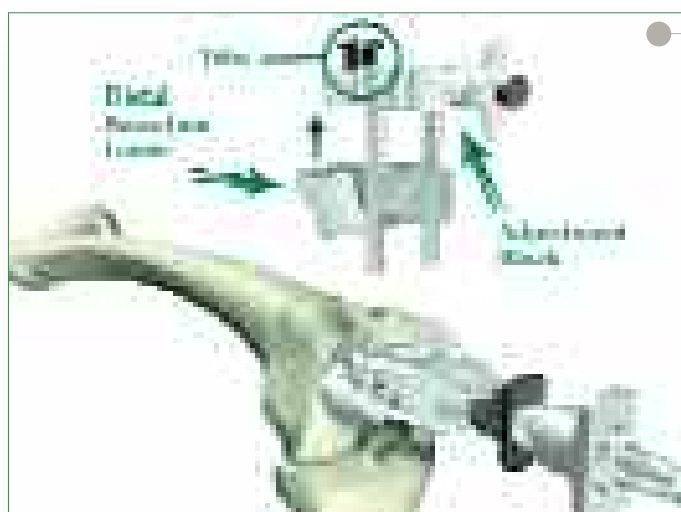

Assembly 1A

Distal Resection Guide, Adjustment Block and Femoral Alignment Guide Assembly:

- ▶ Attach the Distal Resection Guide to the Adjustment Block by squeezing the black tabs on Adjustment Block and sliding into the Distal Resection Guide.
- ▶ Release the black tabs and ensure that the Distal Resection Guide is securely snapped into place.



Assembly 1B

- ▶ Insert the two posts of the Adjustment Block into the holes on the Femoral Alignment Guide (for use on the left or right side). Ensure that the black button on the Adjustment Block is aligned with the black knob on the Femoral Alignment Guide.

Triathlon® Knee System

Surgical Protocol

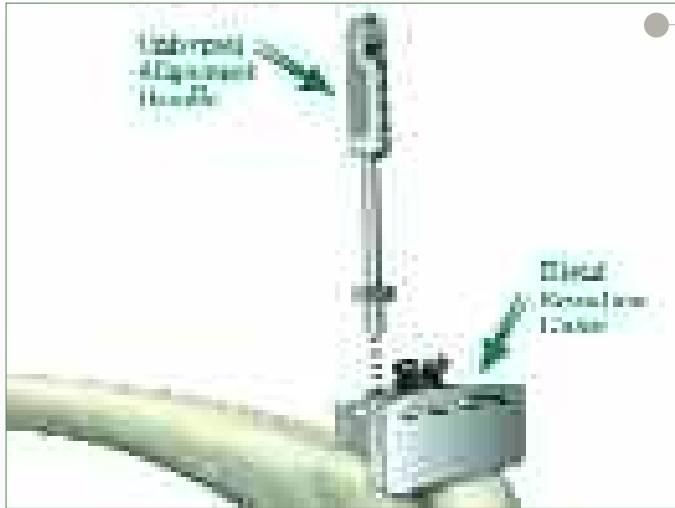

Assembly 2A

Universal Alignment Handle, Distal Resection Guide and Universal Alignment Rod Assembly:

- ▶ Insert the Universal Alignment Handle into the Distal Resection Guide as shown.

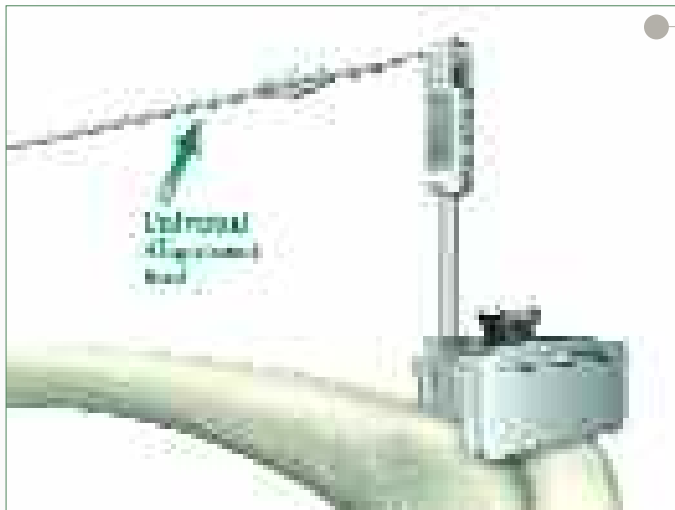

Assembly 2B

- ▶ Insert the Universal Alignment Rod as shown.

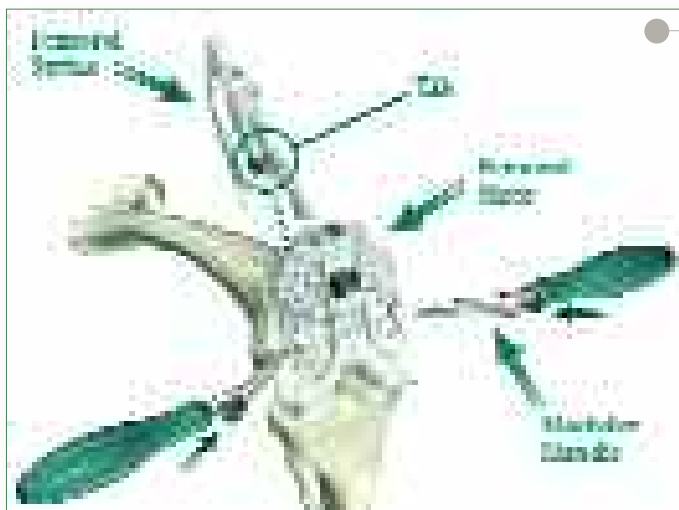

Assembly 3

Femoral Sizer, Femoral Stylus and Modular Handle Assembly:

- ▶ Attach the Femoral Stylus to the appropriate lateral hole of the Femoral Sizer by squeezing the black tab and inserting into the hole. Release the tab to lock into place.
- ▶ Press the black button on the Modular Handle and insert into the holes shown. Release the black button and turn the Modular Handle until it clicks into place.

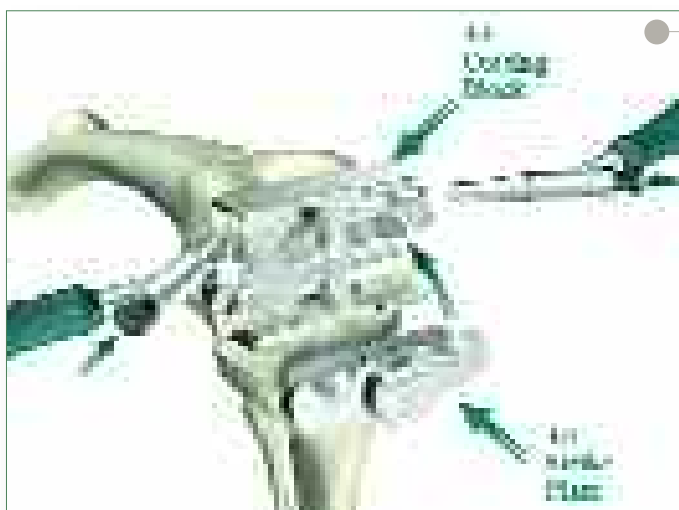

Assembly 4A

4:1 Cutting Block, Modular Handle, 4:1 Strike Plate and 4:1 Modular Capture Assembly:

- ▶ Insert the 4:1 Strike Plate into the anterior chamfer of the 4:1 Cutting Block until it clicks into place.
- ▶ Press the black button on the Modular Handle and insert it into the hole shown. Release the black button and turn the Modular Handle until it clicks into place.



Assembly 4B

- ▶ To attach the 4:1 Modular Capture, turn the black “bow-tie” knob and cam to disengage the magnet from the capture surface.
- ▶ Attach the 4:1 Modular Capture to the anterior or posterior resection surfaces by positioning it to straddle the central web.
- ▶ Once fully seated, turn the “bow-tie” knob to engage the magnet with the captured surface.

Triathlon® Knee System

Surgical Protocol

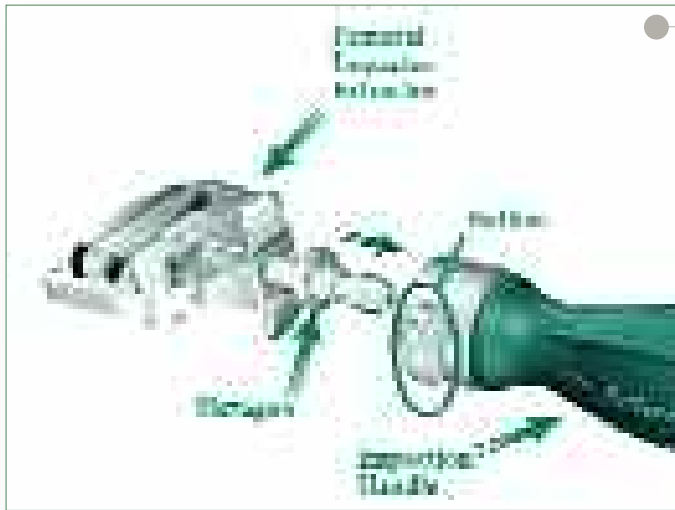

Assembly 5A

Femoral Impactor Extractor, Impaction Handle and Femoral Trial or Femoral Component Assembly:

- ▶ Snap the Femoral Impactor Extractor into the Impaction Handle.
- ▶ Ensure the hexagon on the Femoral Impactor Extractor is fully seated in the Impaction Handle. When fully seated, there will be an audible snap.



Assembly 5B

- ▶ Turn the Impaction Handle counterclockwise until there is enough space (approximately 10mm) between the black impaction surface and the ends of the jaws to insert the Femoral Trial or Femoral Component.
- ▶ Pull back on the mechanism to open the jaws. Engage the jaws into the impaction slots on the Femoral Trial or Femoral Component.
- ▶ Turn the Impaction Handle clockwise to tighten, ensuring the impaction surface locks against the distal condyles of the Femoral Trial or Femoral Component.



Assembly 5C

- ▶ Final Assembly

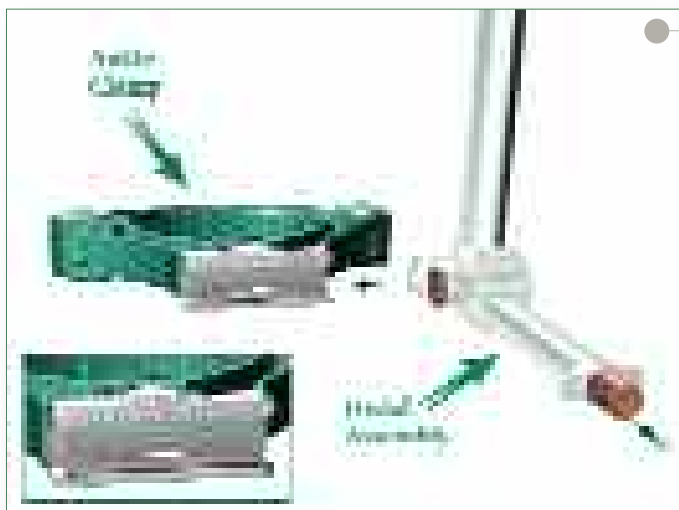

Assembly 6A

Tibial Alignment Ankle Clamp EM, Tibial Alignment Distal Assembly EM, Tibial Alignment Proximal Rod EM, Tibial Stylus, Tibial Resection Guide Modular Capture and Tibial Adjustment Housing Assembly:

Note: The Tibial Adjustment Housing is available in 0° slope (posterior stabilized) and 3° slope (cruciate retaining):

- ▶ Press the bronze button on the Distal Assembly and slide into the grooves on the Ankle Clamp. Ensure that the “proximal” side of the Ankle Clamp is showing (See Inset).

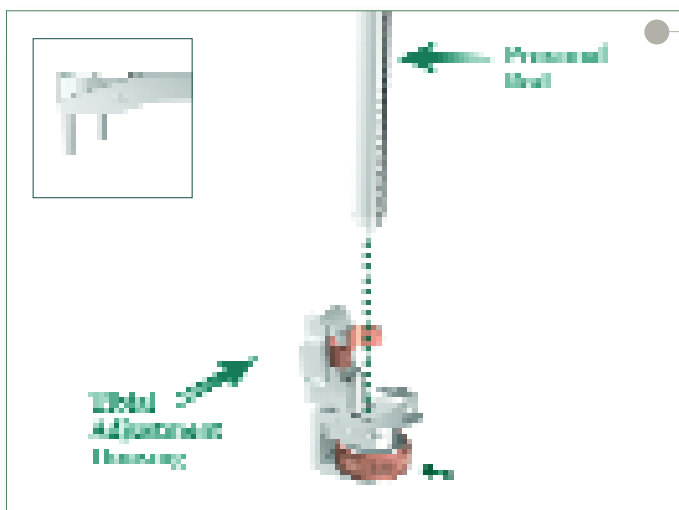

Assembly 6B

- ▶ Press the bronze wheel on the Tibial Adjustment Housing with your thumb and insert the Proximal Rod. Ensure that the two fixation pins on the superior portion of the Proximal Rod (See Inset) are facing posteriorly.



Assembly 6C

- ▶ Slide the Proximal Rod until the Tibial Adjustment Housing engages the teeth on the Proximal Rod.
- ▶ Release the bronze wheel to lock into place.

Triathlon® Knee System

Surgical Protocol



Assembly 6D

- ▶ Ensure that the bronze lock on the Distal Assembly is unlocked prior to insertion.
- ▶ Insert the Proximal Rod and Tibial Adjustment Housing assembly into the hole on the top of the Distal Assembly with the fixation pins on the superior portion of the Proximal Rod facing posteriorly.

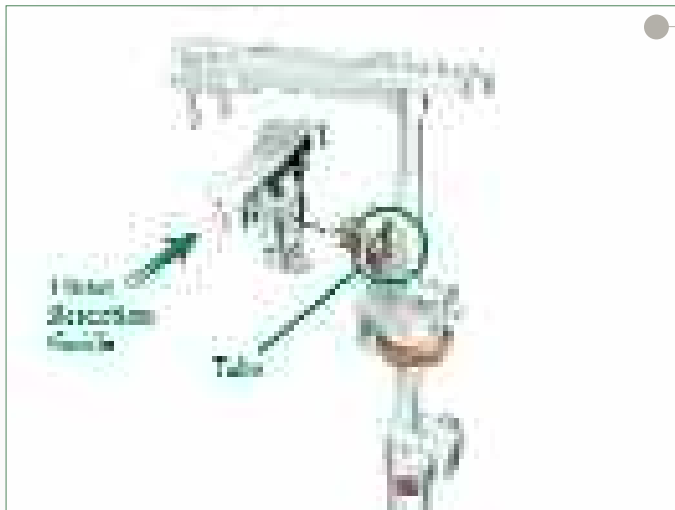

Assembly 6E

- ▶ Squeeze the bronze tabs on the Tibial Adjustment Housing and insert the entire assembly into the Tibial Resection Guide.
- ▶ Release the bronze tabs and ensure that the Tibial Resection Guide is locked in place.

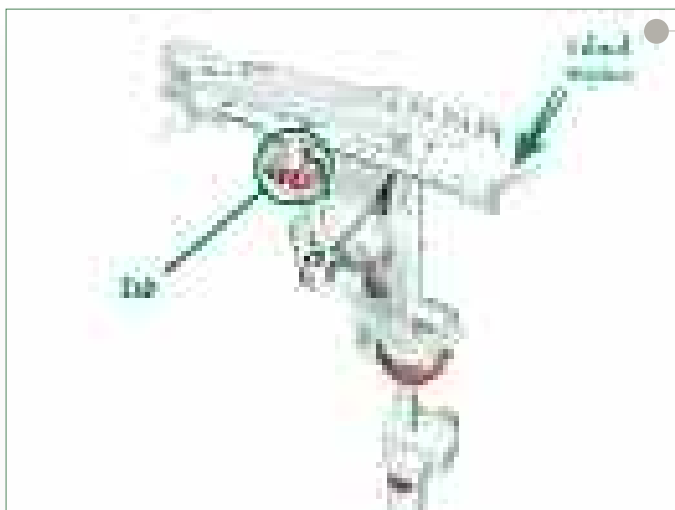

Assembly 6F

- ▶ Squeeze the bronze tab on the Tibial Stylus and insert the post into the appropriate side of the Tibial Resection Guide.
- ▶ Release the bronze tab to lock the Tibial Stylus in place.



Assembly 6G

► Final Assembly

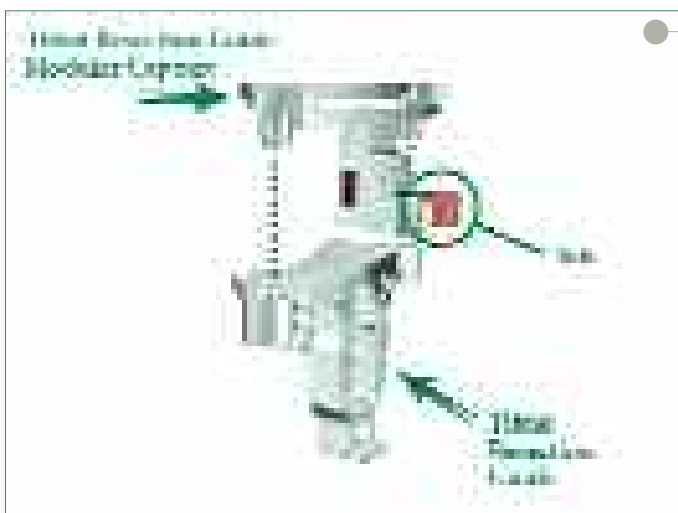

Assembly 6H

- Squeeze the bronze tab on the Tibial Resection Guide Modular Capture to attach it to the Tibial Resection Guide. Locate the posts on the bottom of the Tibial Resection Guide Modular Capture and the post holes on the top surface of the Tibial Resection Guide.
- Insert the posts into the Tibial Resection Guide holes and slide the Tibial Resection Guide Modular Capture into place.
- Release the bronze tab to lock the Tibial Resection Guide Modular Capture into the Tibial Resection Guide.



Assembly 6I

► Final Assembly

Triathlon® Knee System

Surgical Protocol

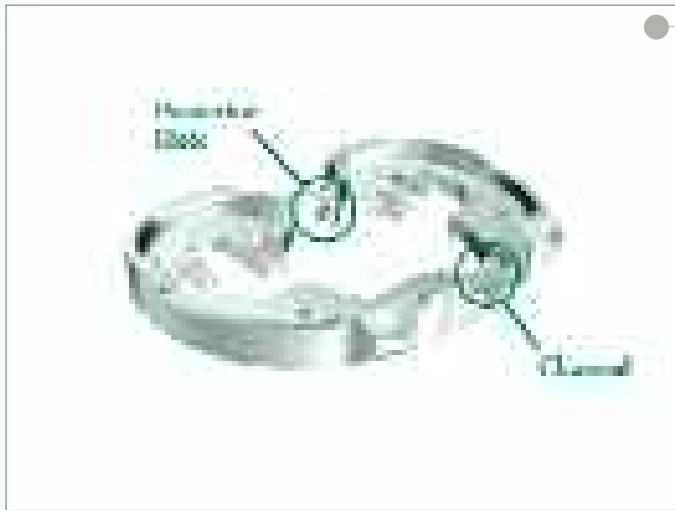

Assembly 7A

Universal Tibial Template, Alignment Handle and PS or CR Tibial Insert Trial Assembly:

- ▶ Posterior hole and Channel of Universal Tibial Template (referenced in Assembly 7B).

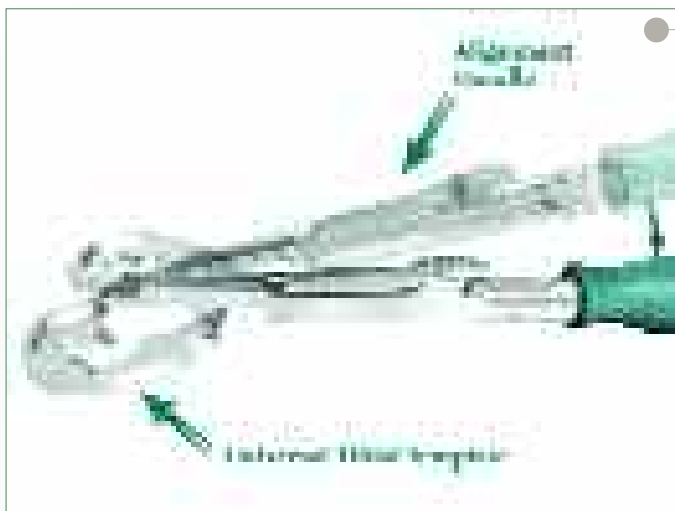

Assembly 7B

- ▶ Depress and hold the lever on the anterior position of the Alignment Handle. Insert the spring-loaded tip of the Alignment Handle into the central posterior hole of the Universal Tibial Template. Hold the handle at a slight angle to the top surface of the template.
- ▶ Compress the spring-loaded tip by pushing it forward and lower the Alignment Handle into the channel on the anterior portion of the Universal Tibial Template. Release the spring tension and allow the Alignment Handle to engage the Universal Tibial Template.
- ▶ Release the lever to secure the assembly.



Assembly 7C

- ▶ Position a PS or CR Tibial Insert Trial to the Universal Tibial Template by first positioning it posteriorly, at a 20-30° angle to the template and then fully seat it anteriorly.

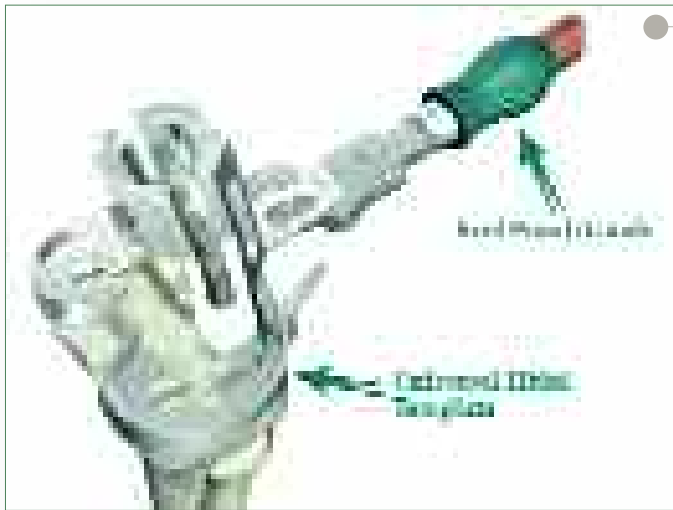

Assembly 8A

Universal Tibial Template and Keel Punch Guide Assembly:

- ▶ Ensure that the handle of the Keel Punch Guide is unlocked – pull back on the handle to unlock.
- ▶ Assemble the Keel Punch Guide to the Universal Tibial Template by inserting the Keel Punch Guide (at a slight angle to the Universal Tibial Template) into the two locating slots towards the posterior portion of the Universal Tibial Template.



Assembly 8B

- ▶ Allow the Keel Punch Guide to sit flat on the Universal Tibial Template and push forward on the handle of the Keel Punch Guide to lock it to the Universal Tibial Template.



Assembly 8C

- ▶ Final Assembly

Triathlon® Knee System

Surgical Protocol

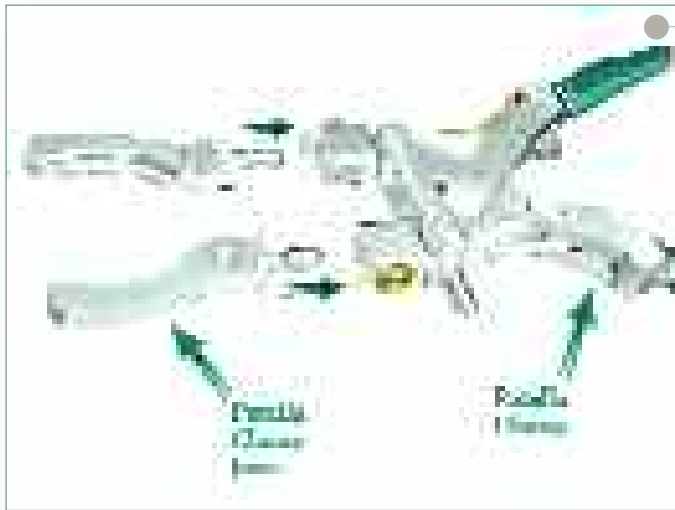

Assembly 9A

Patella Clamp, Patella Stylus and Patella Clamp Jaws Assembly (this may also be used to assemble the Patella Clamp Base, Patella Drill Template and Patella Cement Cap to the Patella Clamp):

- ▶ Snap the Patella Clamp Jaws into the holes on the Patella Clamp.

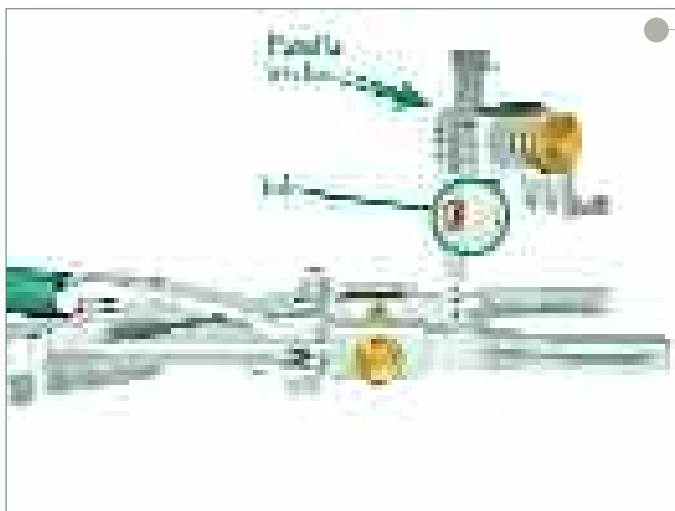

Assembly 9B

- ▶ Squeeze the gold tab on the Patella Stylus and insert the post into the hole on either jaw. Use the holes on the top surface of the jaws if using the Bone Removing Method or on the bottom surface if using the Bone Remaining Method.
- ▶ The top surface has circular holes, which allow the stylus to rotate, and the bottom surface has hex shaped holes fixing the stylus in the center of the patella.
- ▶ Release the gold tab to lock the Patella Stylus in place.

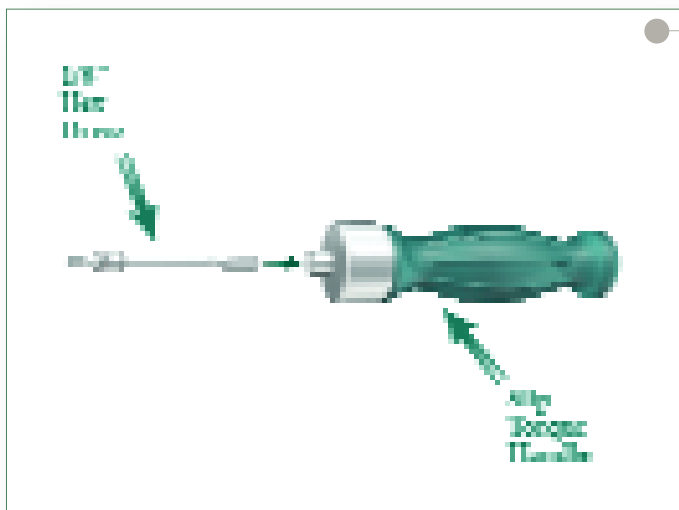

Assembly 10A

1/8" Hex Drive, Slip Torque Handle and Modular Femoral Distal Fixation Pegs Assembly:

- ▶ Snap the 1/8" Hex Drive into the Slip Torque Handle.



Assembly 10B

- ▶ Insert the tip of the 1/8" Hex Drive into the Modular Femoral Distal Fixation Peg and turn the Slip Torque Handle to tighten.

Triathlon® Knee System

Surgical Protocol



Figure 1

Exposure

- ▶ A standard anterior midline incision is utilized. Any previous incision can be used or incorporated to decrease the risk of skin slough.
- ▶ The capsule is entered through a medial parapatellar approach approximately 1cm from the medial border of the patella.
- ▶ Use a soft tissue approach that allows adequate patella visualization and sufficient knee flexion.



Figure 2

Femoral Preparation

Femoral Intramedullary Alignment

- ▶ The Universal Driver allows for attachment of all drills and pins. The Universal Driver may be attached directly to a reamer, drill, or a Jacob's Chuck.
- ▶ Locate the IM drill hole. It is approximately 1cm anterior to the femoral attachment of the posterior cruciate ligament and slightly medial to the midline of the distal femur.
- ▶ Identification of landmarks may be aided by removal of osteophytes from the margins of the intercondylar notch.
- ▶ Attach the 3/8" IM Drill to the Universal Driver and drill into the IM canal. The first diameter will create a tight fit around the IM Rod. If further clearance is desired, continue to drill until the larger step diameter opens the hole. This will allow the IM canal to dictate the position of the rod and avoids the need to "toggle" the drill to create clearance.



Figure 3

- ▶ Attach the T-Handle Driver to the 5/16" IM Rod. Insert the IM Rod into the Femoral Alignment Guide. The Femoral Alignment Guide is designed for use on either the left or right knee and may be set to 5, 6 or 7° of valgus. Set the instrument to the desired angle by pulling back on the black knob of the Femoral Alignment Guide and placing it in the appropriate notch. Advance the rod, with attached guide, slowly up the IM canal until the desired depth is reached.

Instrument Bar



Figure 4

- ▶ Snap the Distal Resection Guide onto the Adjustment Block and insert the posts of the Adjustment Block into the two holes in the Femoral Alignment Guide (See Assembly 1).
- ▶ Place the Femoral Alignment Guide in contact with the more prominent distal femoral condyle and align the guide in neutral rotation. Although the posterior condyles and the epicondyles may be used as landmarks for rotation, determining I/E rotation is not necessary at this time.
- ▶ Impact the distal captured pins in the Femoral Alignment Guide to aid in stabilization.

6541-4-801
Universal Driver



6541-4-538
3/8" IM Drill



6541-4-800
T-Handle Driver



6541-4-516
5/16" IM Rod



6541-1-657
Femoral Alignment Guide



6541-1-721
Distal Resection Guide

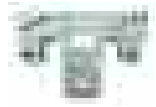

6541-1-600
Adjustment Block



Triathlon® Knee System

Surgical Protocol

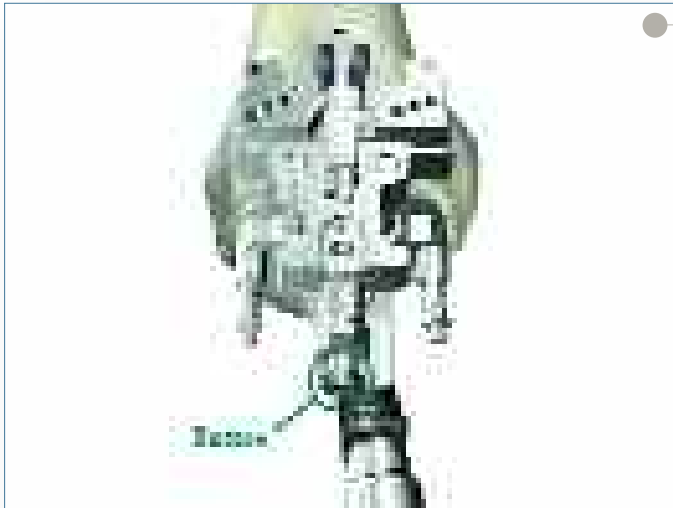

Figure 5

- ▶ The Adjustment Block allows for a 8mm (the distal thickness of the femoral component) and 10mm (used to aid in the correction of a flexion contracture) resection level.
- ▶ Press the black button on the end of the Adjustment Block and pull to set the resection to the desired level.



Figure 6

- ▶ The Triathlon® Knee System Instruments allow for a clear view of the bone that is being resected to ensure the appropriate level is set.
- ▶ Slide the Adjustment Block Assembly within the Femoral Alignment Guide until the Distal Resection Guide contacts the anterior surface of the femur.

Instrument Bar



Figure 7

- ▶ Prior to pinning the Distal Resection Guide to the femur, an optional external alignment check may be performed. Attach the Universal Alignment Handle to the Distal Resection Guide and insert a Universal Alignment Rod into the handle (See Assembly 2).
- ▶ Alignment is correct when the rod intersects the center of the femoral head and roughly parallels the axis of the femur in the lateral view.



6541-1-600
Adjustment Block



6541-1-657
Femoral Alignment Guide

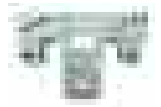

6541-1-721
Distal Resection Guide



6541-4-806
Universal Alignment Handle



6541-4-602
Universal Alignment Rods

Triathlon® Knee System

Surgical Protocol

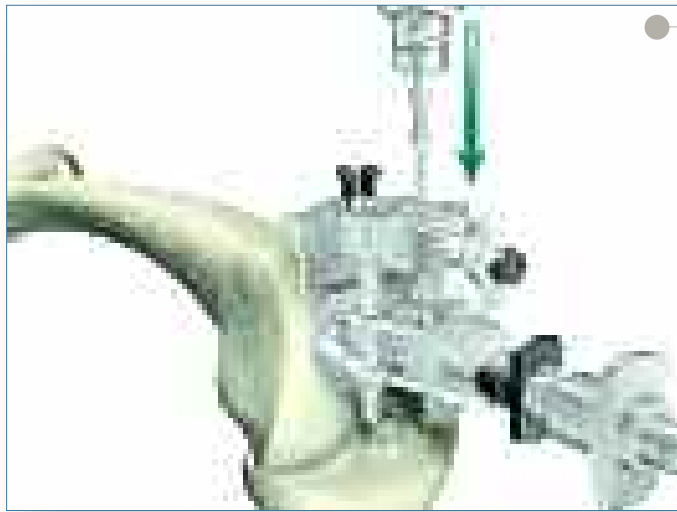

Figure 8

- ▶ Once alignment is confirmed, remove the Universal Alignment Handle and the Universal Alignment Rod.
- ▶ Pin the Distal Resection Guide to the anterior femur using Headless Pins. Insert the pins into the Headless Pin Driver (which is inserted into the Universal Driver) and drill through the set of holes marked “0” on the Distal Resection Guide. The pins are automatically released from the driver as it is pulled back.

Note: If the medial “0” pin hole is too close to the edge of the bone (on smaller femurs), use the holes marked “2” which are closer to the center of the bone.

Note: Ensure that 1/2" of the pin is protruding from all guides after insertion. This will aid in pin removal.

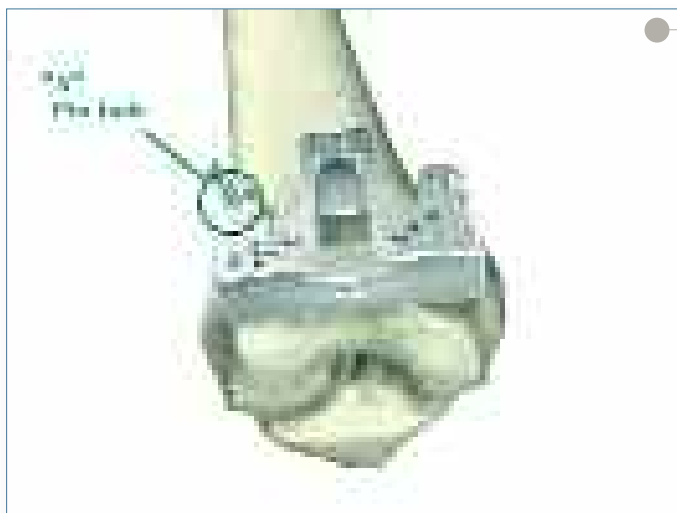

Figure 9

- ▶ After the Distal Resection Guide is pinned in place, remove the IM rod. The Femoral Alignment Guide and the Adjustment Block may be removed by squeezing the black tabs on the Adjustment Block.
- ▶ Pinning through the “X” pin-hole will aid in further securing the guide.

Note: If the “X” pin-hole is used, the pin must be removed prior to repositioning or removing the Distal Resection Guide.



Figure 10

Distal Femoral Resection

- ▶ The distal resection level may be altered by repositioning the Distal Resection Guide in either the 2 or 4 holes. This will remove an additional 2mm or 4mm of bone, respectively.
- ▶ Once the final resection level is determined, the distal femoral resection is made. An optional Modular Capture - Distal Resection may be attached to the Distal Resection Guide. Squeeze the black tabs on the Modular Capture - Distal Resection to insert into the Distal Resection Guide.
- ▶ The Triathlon® Knee System Instruments are designed to provide control of the saw blade during bone resections. When using Modular Captures or cutting through slots, a .050" (1.25mm) blade is used.



Figure 11

- ▶ Remove the Headless Pins by placing the Headless Pin Extractor over the pin and place it flush on the Distal Resection Guide. Squeeze the handle approximately four times, ensuring that after each squeeze, the Headless Pin Extractor is placed flush with the Distal Resection Guide. This will allow the tongue on the Headless Pin Extractor to back out the pin.
- ▶ Remove the Distal Resection Guide and check the resection for flatness.

Instrument Bar

6541-1-721

Distal Resection Guide



6541-4-003

Headless Pins - 3"



6541-4-809

Headless Pin Driver



6541-4-801

Universal Driver



6541-4-400

Bladerunner



6541-1-723

Modular Capture - Distal Resection



6541-4-804

Headless Pin Extractor



Triathlon® Knee System

Surgical Protocol

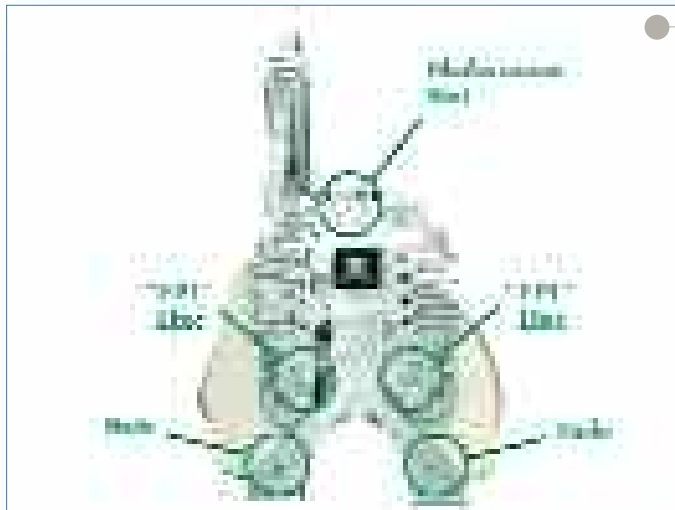

Figure 12

Femoral Sizing

- ▶ Assemble the Femoral Sizer with the Femoral Stylus in the appropriate lateral hole, setting the stylus length to an approximate size. Set the rotation to “LEFT” for a left leg and “RIGHT” for a right leg. This setting equals 3° of external rotation (See Assembly 3).
- ▶ A secondary rotational check can be made by lining up the epicondyles with the reference lines marked “EPI”. A tertiary check is to assess Whiteside’s line with the Bladerunner through the slot in the top of the guide.
- ▶ Optional Modular Handles may be assembled to the Femoral Sizer to assist in stabilization (See Assembly 3).
- ▶ In the event of Hypoplasia:
Pin the Femoral Sizer through the hole on the unaffected side for stability. Rotate the Femoral Sizer and assess rotation using the rotational checks mentioned above.

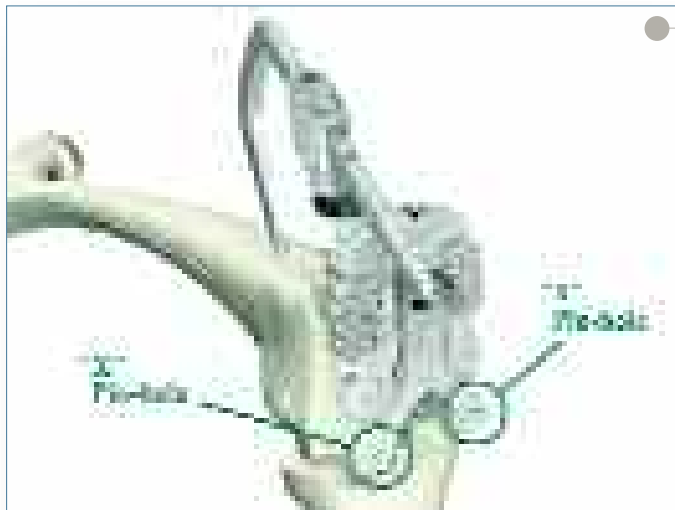

Figure 13

- ▶ Position the assembly flush on the resected distal femur, sliding the feet of the Femoral Sizer under the posterior condyles. The Femoral Stylus point should be placed on the lateral cortex.
- ▶ It is important that the Femoral Stylus point rest on bone and not soft tissue.
- ▶ The Femoral Sizer may be pinned in place through the holes marked “X” with Headless Pins.

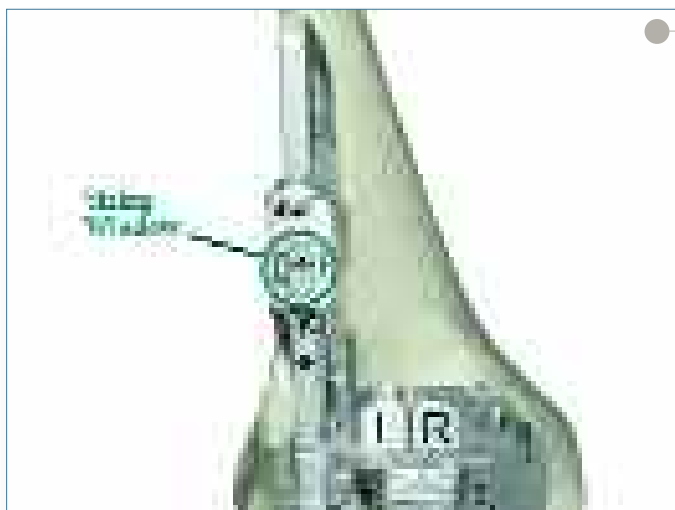

Figure 14

- ▶ The size is determined by the position of the scribe mark on the Femoral Stylus shaft within the sizing window.

Instrument Bar

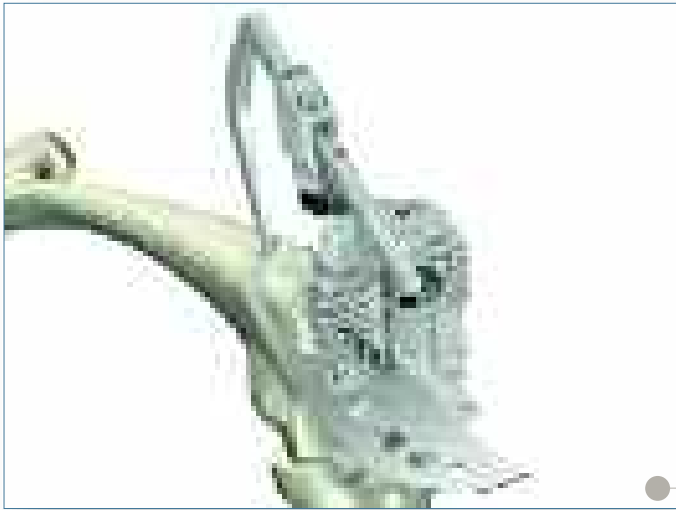

Figure 15

- ▶ It is recommended that the anterior resection level be checked to further confirm the correct size by sliding a Bladerunner through the sizing guide's size-specific anterior slots and assessing the resection.

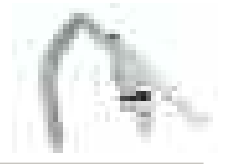

Figure 16

- ▶ Once size confirmation is complete, attach the 1/8" Peg Drill to the Universal Driver and create fixation pin-holes (for the 4:1 Cutting Block) through the holes on the face of the Femoral Sizer marked "EPI".



6541-1-603
Femoral Sizer



6541-1-605
Femoral Stylus



6541-4-400
Bladerunner



6541-4-003
Headless Pins - 3"



6541-4-809
Headless Pin Driver



6541-4-801
Universal Driver



6541-4-518
1/8" Peg Drill

Triathlon® Knee System

Surgical Protocol

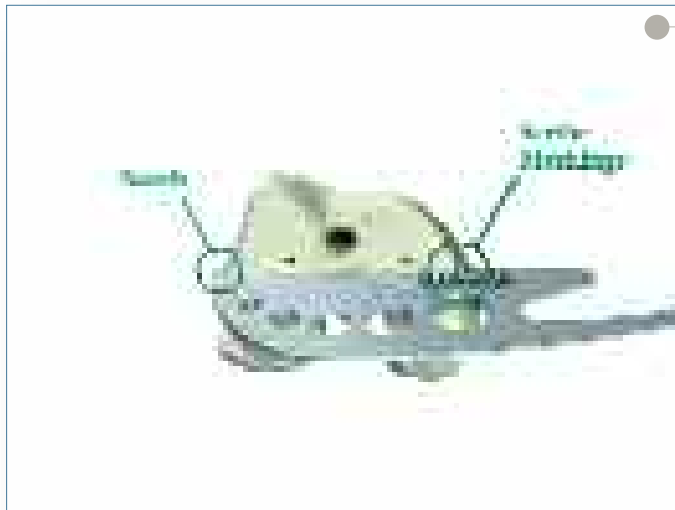

Figure 17

- ▶ Remove the Headless Pins using the Headless Pin Extractor.
- ▶ As a secondary sizing check, use the Bladerunner to check the M/L width of the Femoral component.
- ▶ Line the Bladerunner up with the epicondyles and determine the component size. Ensure that the notch of the Bladerunner is on the outside of the femur. The Bladerunner scribe marks correspond to component sizes 1 through 8. If the M/L width is between sizes, the 4:1 Cutting Block can be down-sized if needed.

Note: For accurate size determination, ensure that all osteophytes on the medial and lateral condyles are removed prior to sizing.



Figure 18

Femoral Anterior, Posterior, and Chamfer Resections

- ▶ Locate the fixation pegs of the appropriate size 4:1 Cutting Block into the pin holes created on the distal femur.
- ▶ Attach the 4:1 Strike Plate to the 4:1 Cutting Block (See Assembly 4A).



Figure 19

- ▶ Impact the 4:1 Strike Plate until the 4:1 Cutting Block is seated flush onto the distal femur.

Note: Do not impact the 4:1 Cutting Block without the 4:1 Strike Plate in place.

Instrument Bar



Figure 20

- ▶ Remove the 4:1 Strike Plate from the 4:1 Cutting Block.



Figure 21

- ▶ Modular handles may be assembled to the 4:1 Cutting Block to aid in both stabilization and removal. Headless Pins may be utilized for further stabilization (See Assembly 4A).

6541-4-003

Headless Pins - 3"



6541-4-809

Headless Pin Driver



6541-4-801

Universal Driver



6541-4-804

Headless Pin Extractor



6541-4-400

Bladerunner



1 - **6541-1-701**

2 - **6541-1-702**

3 - **6541-1-703**

4 - **6541-1-704**

5 - **6541-1-705**

6 - **6541-1-706**

7 - **6541-1-707**

8 - **6541-1-708**

4:1 Cutting Block



6541-1-805

4:1 Strike Plate



6541-4-808

Modular Handle



Triathlon® Knee System

Surgical Protocol



Figure 22

- ▶ Complete the remaining four femoral bone resections.
- ▶ The use of a .050" (1.25mm) thick saw blade is recommended.
- ▶ The order of bone resections is not critical; however, a recommended sequence for improved stability of the 4:1 Cutting Block is:
 - ▶ 1. Anterior cortex. The 4:1 Modular Capture may be added for the anterior resection (**See Assembly 4B**).

Note: Check run-out of the anterior cut. If there is a pronounced positive step, consider selecting the next smaller size 4:1 Cutting Block if the anterior femur preparation is not adequate.



Figure 23

- ▶ 2. Posterior condyles. A Modular Capture may be added for the posterior resection (**See Assembly 4B**).



Figure 24

- ▶ 3. Posterior chamfer through the permanent capture on the 4:1 Cutting Block.

Instrument Bar



Figure 25

- ▶ 4. Anterior chamfer through the permanent capture on the 4:1 Cutting Block.
- ▶ When performing the anterior chamfer resection, the saw blade should be passed over the midline of the femur so that the center portion of bone is resected.
- ▶ Care should be taken not to bias the blade while resecting the bone, as it will cause excess friction between the blade and the 4:1 Cutting Block.

1 - **6541-1-701**

2 - **6541-1-702**

3 - **6541-1-703**

4 - **6541-1-704**

5 - **6541-1-705**

6 - **6541-1-706**

7 - **6541-1-707**

8 - **6541-1-708**

4:1 Cutting Block



6541-1-806

4:1 Modular Capture



Triathlon® Knee System

Surgical Protocol



Figure 26

- ▶ Remove the 4:1 Cutting Block.
- ▶ If preparing for a Cruciate Retaining Knee where no PS box preparation is needed, proceed to Femoral Trial Assessment on page 32.

PS Box Preparation

- ▶ If it is determined that a PS component will be used, the box must be prepared on the distal femur.
- ▶ Place the appropriate size (universal left or right) PS Box Cutting Guide on the resected distal femur. With the exception of the anterior geometry the guide matches the periphery of the corresponding implant. The anterolateral border of the PS Box Cutting Guide represents the actual lateral periphery of the implant (either left or right). On the anteromedial side of the PS Box Cutting Guide, an engraved line represents the corresponding medial curvature of the left or right component (inset). M/L placement of the guide is based primarily on best coverage of the distal bone and alignment of the box opening with the intercondylar notch. The lateral anterior periphery and medial engraved line may also be used as references.
- ▶ Pin the PS Box Cutting Guide using Headless Pins in the holes on the anterior surface of the PS Box Cutting Guide.
- ▶ Additional Headless Pins can be placed in the distal pin holes if additional fixation is required.



Figure 27

The PS box preparation sequence is as follows:

- ▶ Using the inside surfaces of the box opening as guides, cut the cartilage on both sides of the posterior portion of the intercondylar notch using the oscillating saw.
- ▶ Insert the Box Chisel into the Impaction Handle by pressing the button on the Impaction Handle and snapping the Box Chisel in place. Insert this assembly into the slot and impact until seated to the stop. Care should be taken to visualize posterior soft tissue structures, which should be retracted from the path of the chisel. The surface marked "DISTAL" on the Box Chisel should be oriented as shown.

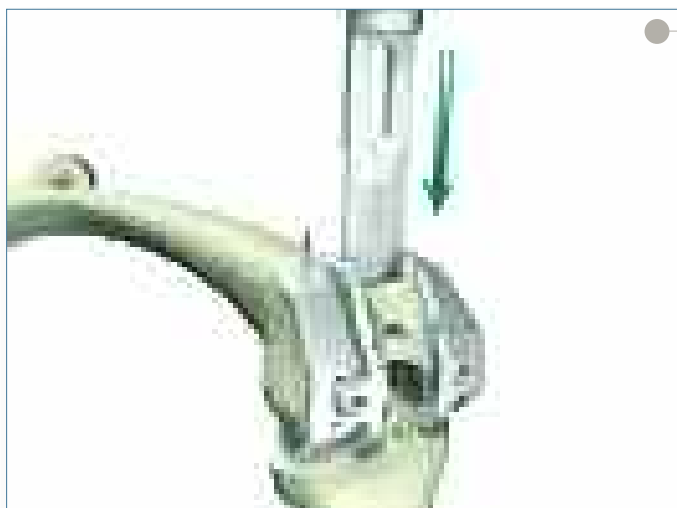

Figure 28

Instrument Bar

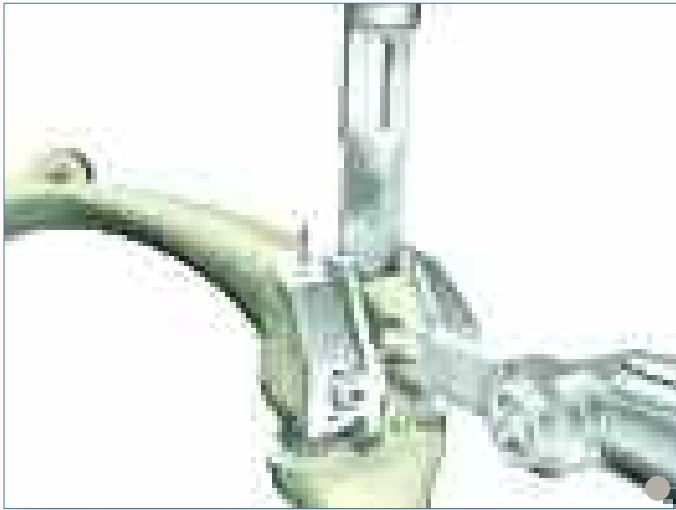

Figure 29

- ▶ Cut the box area using the edges of the box opening as guides. Avoid biasing the blade during resection for optimal bone conservation.
- ▶ Avoid biasing the blade during resection for optimal bone conservation.

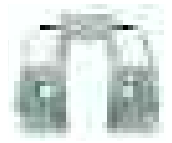

Figure 30

- ▶ Attach the Slap Hammer to the Box Chisel. Remove the Box Chisel from the PS Box Cutting Guide and remove the bone.

- # 1 - **6541-1-711**
- # 2 - **6541-1-712**
- # 3 - **6541-1-713**
- # 4 - **6541-1-714**
- # 5 - **6541-1-715**
- # 6 - **6541-1-716**
- # 7 - **6541-1-717**
- # 8 - **6541-1-718**

PS Box Cutting Guide



6541-4-003

Headless Pins - 3"



6541-4-809

Headless Pin Driver



6541-4-810

Impaction Handle



6541-4-801

Universal Driver



6541-4-709

Box Chisel



6541-4-803

Slap Hammer



Triathlon® Knee System

Surgical Protocol



Figure 31

- ▶ If Modular Femoral Distal Fixation Pegs are to be used, the location holes may be prepared at this stage using the 1/4" Peg Drill attached to the Universal Driver. (The peg holes may also be prepared later through the PS Femoral Trial).

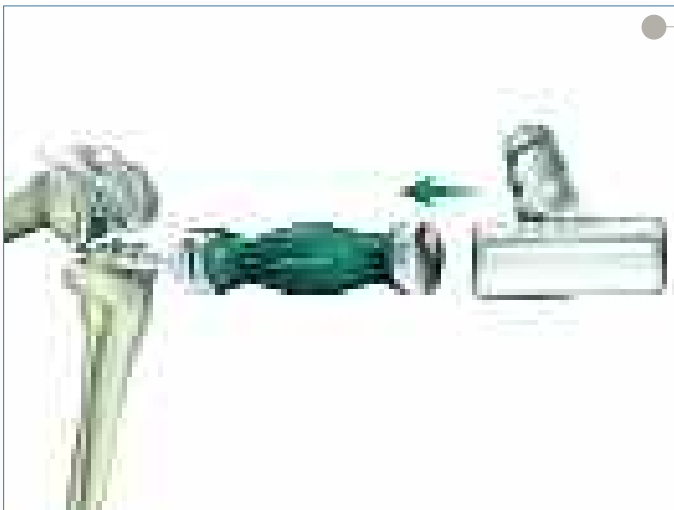

Figure 32

- ▶ Attach the Posterior Osteophyte Removal Tool to the Impaction Handle and remove the osteophytes beyond the posterior aspect of the PS Box Cutting Guide.
- ▶ Remove the Headless Pins with the Headless Pin Extractor.
- ▶ Remove the PS Box Cutting Guide using the Slap Hammer.

Note: If it is difficult to reach the posterior osteophytes in a tight knee, the tibial resection can be made and then the osteophytes can more easily be removed.



Figure 33

Femoral Trial Assessment

(The remaining portion of the technique should be used for a Posterior Stabilized or Cruciate Retaining knee)

- ▶ Assemble the appropriate size and side (Left/Right) PS or CR Femoral Trial to the Femoral Impactor Extractor with the Impaction Handle (See Assembly 5).



Figure 34

- ▶ Impact the PS or CR Femoral Trial onto the prepared distal femur. Use the Impaction Handle to ensure the Femoral Trial is aligned with the distal plane.

Instrument Bar

6541-4-525

1/4" Peg Drill



6541-4-801

Universal Driver



1 - 6541-1-711

2 - 6541-1-712

3 - 6541-1-713

4 - 6541-1-714

5 - 6541-1-715

6 - 6541-1-716

7 - 6541-1-717

8 - 6541-1-718

PS Box Cutting Guide

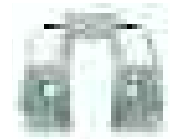

6541-4-710

Posterior Osteophyte Removal Tool



6541-4-810

Impaction Handle



6541-4-804

Headless Pin Extractor

6541-4-803

Slap Hammer



See Catalog

PS Femoral Trial



See Catalog

CR Femoral Trial



6541-4-807

Femoral Impactor Extractor



Triathlon® Knee System

Surgical Protocol



Figure 35



Figure 36

- ▶ Remove the Femoral Impactor Extractor and Impaction Handle and assess the fit of the PS or CR Femoral Trial. Care must be taken to ensure that all of the osteophytes beyond the end of the posterior femoral condyles are removed.

- Cruciate Retaining Knee: Attach the 1/4" Peg Drill to the Universal Driver and create the Modular Femoral Distal Fixation Peg holes. Attach the Posterior Osteophyte Removal Tool to the Impaction Handle and remove posterior osteophytes.

Note: If it is difficult to reach the posterior condyles in a tight knee, the tibial resection can be made and then the osteophytes can more easily be removed.

- Posterior Stabilized Knee: If the Modular Femoral Distal Fixation Pegs are to be used, and the holes were not prepared through the PS Box Cutting Guide, use the 1/4" Peg Drill, attached to the Universal Driver to prepare the distal femoral peg holes.

- ▶ Attach the Femoral Impactor Extractor to the Slap Hammer and remove the PS or CR Femoral Trial from the femur.



Figure 37

Tibial Preparation

- ▶ There are two options for tibial preparation: extramedullary (EM) referencing alignment and intramedullary (IM) referencing alignment.
- ▶ The Tibial Resection Guide, available in Left and Right configurations, is designed to avoid soft tissue impingement.

Instrument Bar

6541-4-525

1/4" Peg Drill



6541-4-801

Universal Driver



6541-4-710

Posterior Osteophyte Removal Tool



6541-4-810

Impaction Handle



6541-4-807

Femoral Impactor Extractor



6541-4-803

Slap Hammer



Right 6541-2-700

Left 6541-2-701

Tibial Resection Guide



Femoral
Preparation

Tibial
Preparation

Triathlon® Knee System

Surgical Protocol

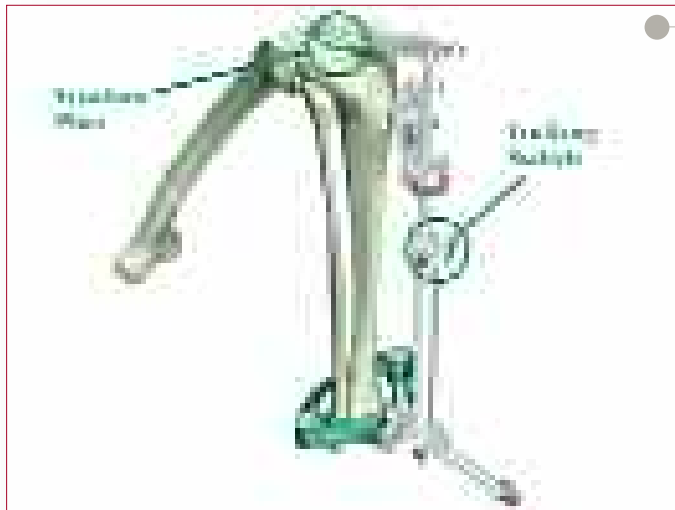

Figure 38



Figure 39



Figure 40

Option 1 – Extramedullary Referencing

- ▶ The tibial resection assembly has five parts: the appropriate Tibial Resection Guide, the Ankle Clamp, the Distal Assembly, the Proximal Rod and the Tibial Adjustment Housing. These are assembled first (See Assembly 6).

Note: The Tibial Adjustment Housing is available in 0° slope (posterior stabilized) and 3° slope (cruciate retaining).

Flexion/Extension Alignment

- ▶ The posterior long fixation pin of the Proximal Rod is partially seated in the proximal tibia to stabilize the assembly. Place the ankle clamp around the ankle and unlock the locking switch.
- ▶ Flexion/Extension alignment is correct when the long axis of the assembly parallels the mid-coronal plane of the tibia. Flexion/Extension alignment can be checked by verifying that the long axis of the assembly is parallel to the fibula.

Varus/Valgus Alignment

- ▶ Medial/Lateral offset can be adjusted by pushing the bronze button (1) and sliding the assembly medially until the shaft intersects the center of the tibia.
- ▶ Once triaxial alignment is achieved, release the bronze button.

Tibial Slope Adjustment

Note: If the Proximal Rod is parallel to the tibia, the slope is 0° or 3° depending on which Tibial Adjustment Housing is used.

- ▶ Tibial slope can be adjusted by pressing the bronze button (2).

Rotational Alignment

- ▶ Rotate the entire assembly to ensure that the base of the assembly is aligned with the center of the ankle. The center of the ankle is generally in line with the second metatarsal.
- ▶ Fix the entire assembly in place by striking the proximal end of the Proximal Rod with a mallet, securing the two fixation pins.

Once alignment is confirmed, set the bronze locking switch on the Distal Assembly to the locked position.



Figure 41

Option 2 – Intramedullary Referencing

- ▶ Attach the 3/8" IM Drill to the Universal Driver and create a hole in the location determined by the preoperative X-rays.



Figure 42

- ▶ Attach the T-Handle Driver to the 5/16" IM Rod and slowly pass into the canal, ensuring clearance. Remove the 5/16" IM Rod and insert it into the body of the Tibial Alignment Jig IM. The assembly is then inserted into the canal until the isthmus is engaged.

Instrument Bar

Right 6541-2-700

Left 6541-2-701

Tibial Resection Guide



6541-2-610

Tibial Alignment Distal Assembly EM



6541-2-609

Tibial Alignment Ankle Clamp EM



6541-2-611

Tibial Alignment Proximal Rod EM



0° slope 6541-2-704

3° slope 6541-2-705

Tibial Adjustment Housing



6541-4-538

3/8" IM Drill



6541-4-801

Universal Driver



6541-4-800

T-Handle Driver



6541-4-516

5/16" IM Rod



6541-2-600

Tibial Alignment Jig IM



Triathlon® Knee System

Surgical Protocol

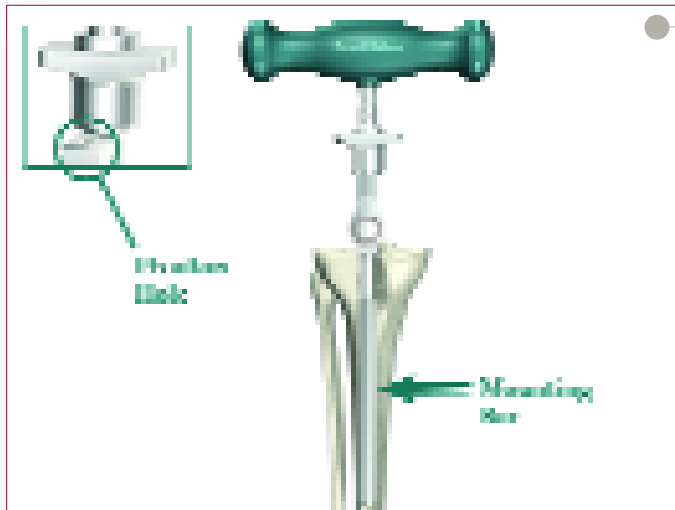

Figure 43

Rotational Alignment

- ▶ With the body of the Tibial Alignment Jig IM resting on the proximal tibia, proper rotational alignment is achieved by rotating the instrument about the 5/16" IM Rod so that the vertical mounting bar is over the medial 1/3 of the tibial tubercle. A Headless Pin or the 1/8" Drill are then inserted into the fixation hole to fix rotation (See Inset).



Figure 44

Varus/Valgus Alignment

- ▶ Assemble the appropriate Tibial Resection Guide (left or right) and Tibial Adjustment Housing (See Assembly 6E).
- Note:** The Tibial Adjustment Housing is available in 0° slope (posterior stabilized) and 3° slope (cruciate retaining).
- ▶ Attach the assembly onto the mounting bar by pressing the bronze wheel on the Tibial Adjustment Housing. Attach the Universal Alignment Handle to the Tibial Resection Guide and slide a Universal Alignment Rod through the handle for sagittal assessment.
 - ▶ When alignment is confirmed, the Universal Alignment Handle should be centered over the ankle.

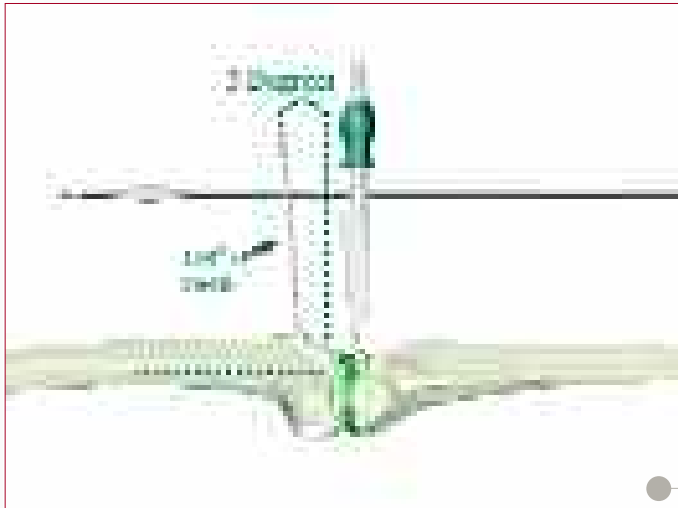

Figure 45

[The following applies to both extramedullary and intramedullary alignment.]

Establish Tibial Resection Level

- ▶ The Tibial Stylus attaches to the Tibial Resection Guide with the “9” end referencing the lowest level of the unaffected compartment (See Assembly 6F).
- ▶ 9mm of bone will be resected. Alternatively, if the “2” end of the Tibial Stylus is used, the amount of bone resected will be 2mm below the tip of the stylus.
- ▶ The height of the Tibial Resection Guide, Tibial Stylus and Tibial Adjustment Housing can be adjusted using the bronze wheel on the Tibial Adjustment Housing. For coarse adjustment, press the bronze wheel and slide the assembly up or down. For fine adjustment, turn the bronze wheel to the right to move the assembly up the Proximal Rod or turn left to move the assembly down the Proximal Rod.
- ▶ Place two Headless Pins into the “0” [neutral] holes, fixing the level of the Tibial Resection Guide.
- ▶ If additional stability of the guide is required, utilize the oblique “X” pin-hole.

Instrument Bar

6541-2-600

Tibial Alignment Jig IM

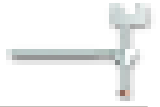

6541-4-800

T-Handle Driver



6541-4-516

5/16" IM Rod



6541-4-003

Headless Drill-Pins - 3"



6541-4-809

Headless Pin Driver



6541-4-801

Universal Driver



3170-0000

1/8" Drill



Right 6541-2-700

Left 6541-2-701

Tibial Resection Guide



0° slope 6541-2-704

3° slope 6541-2-705

Tibial Adjustment Housing



6541-4-806

Universal Alignment Handle



6541-2-611

Tibial Alignment Proximal Rod EM



6541-4-429

Tibial Stylus



Triathlon® Knee System

Surgical Protocol



Figure 46

- ▶ Remove all alignment instruments leaving only the Tibial Resection Guide in place.
 - If Option 1 EM Alignment was used: The Ankle Clamp, Distal Assembly, Proximal Rod and Tibial Adjustment Housing are removed. To remove the assembly, release the bronze lock switch, squeeze the bronze wheel on the Tibial Adjustment Housing and lift the lever arm on the Proximal Rod while holding the wheel release high enough to clear pins. Squeeze the bronze tabs and remove the ankle clamp assembly. This will allow the assembly to disengage from the Tibial Resection Guide and release the fixation pegs from the plateau.
 - If Option 2 IM Alignment was used: Squeeze the bronze tabs on the Tibial Adjustment Housing to disengage the assembly from the Tibial Resection Guide. Slide the Tibial Adjustment Housing anteriorly. Remove the 5/16" IM Rod, the Tibial Alignment Jig IM, the Tibial Adjustment Housing and the Universal Alignment Handle.

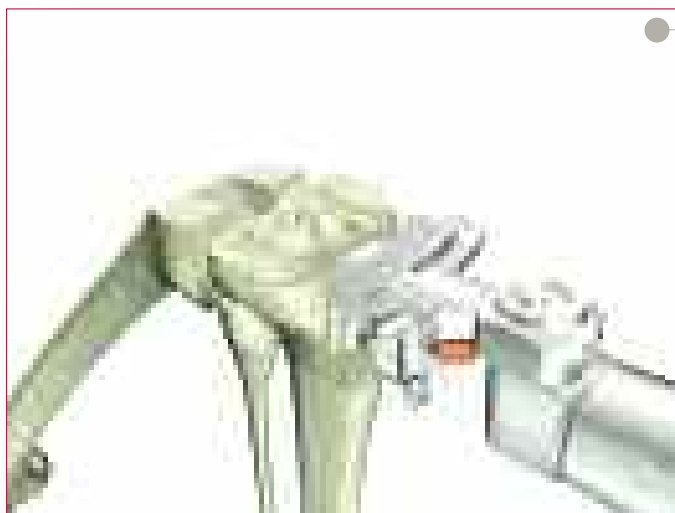

Figure 47

Tibial Resection

- ▶ Resection of the proximal tibia is now completed. An optional Tibial Resection Guide Modular Capture (Left or Right) may be added (**Assembly 6H**).
- ▶ Remove the Tibial Resection Guide.



Figure 48

Flexion and Extension Gaps

- ▶ The flexion gap (90°) and extension gap (0°) may be assessed using the Adjustable Spacer Block. The numbers on the thumbwheel correspond to the implant insert thickness. Lift the Upper Paddle Grip to free the adjustment wheel. Align the notch with the appropriate thickness (See Inset) and assess the gap space until the appropriate insert thickness is established.
- ▶ A Universal Alignment Rod can be placed through the hole on the Adjustable Spacer Block to check alignment.



Figure 49

Tibial Component Sizing

- ▶ Place the PS or CR Femoral Trial on the femur.
- ▶ Sublux the tibia anteriorly. Assemble a Universal Tibial Template, Alignment Handle and a PS or CR Tibial Insert Trial (See Assembly 7).
- ▶ Place the assembly on the resected tibial plateau and choose the size that best addresses rotation and coverage.
- ▶ Perform a trial reduction to assess overall component fit, ligament stability and joint range of motion.

Note: Ensure all excess debris (bone and soft tissue) is cleared from the Universal Tibial Template.

Instrument Bar

Right 6541-2-702
Left 6541-2-703



Tibial Resection Guide Modular Capture

6541-4-610

Adjustable Spacer Block



6541-4-602

Universal Alignment Rods



See Catalog

PS Femoral Trial



See Catalog

CR Femoral Trial



1 - **6541-1-601**

2 - **6541-1-602**

3 - **6541-1-603**

4 - **6541-1-604**

5 - **6541-1-605**

6 - **6541-1-606**

7 - **6541-1-607**

8 - **6541-1-608**



Universal Tibial Template

Triathlon® Knee System

Surgical Protocol

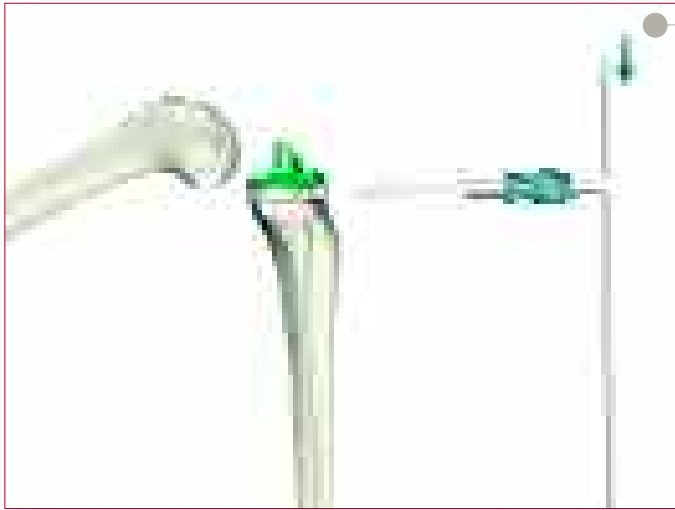

Figure 50

Tibial Trial Assessment

- ▶ For an optional tibial alignment check, insert a Universal Alignment Rod into the most anterior hole of the Alignment Handle and check alignment.

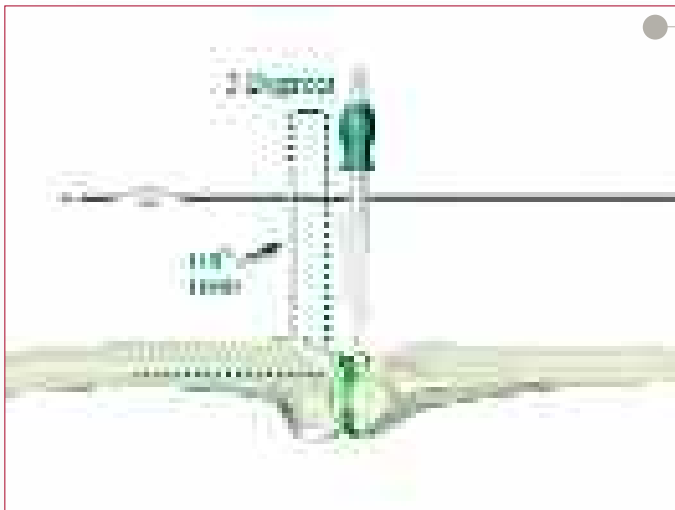

Figure 51

- ▶ Place the knee in full extension and assess overall alignment in the A/P and M/L planes.
- ▶ A 1/8" drill can be inserted into the lateral hole on the anterior surface of the Femoral Trial to aid in alignment.



Figure 52

► There are two options to secure the Universal Tibial Template to the tibia:

- Option 1: Once satisfactory alignment and tibial component orientation are achieved, remove the PS or CR Femoral Trial. Place two Headless Pins in the anterior holes of the Universal Tibial Template, disassemble the Tibial Trial Insert from the Universal Tibial Template, and secure by pinning.
- Option 2: Once satisfactory alignment and tibial component orientation are achieved, mark the anterior tibial cortex in line with the reference marks on the anterior border of the Universal Tibial Template. Remove the PS or CR Femoral Trial and disassemble the Tibial Trial Insert from the Universal Tibial Template. Reposition the Universal Tibial Template (if required) by aligning the anterior reference marks on the template with the reference marks on the anterior cortex. The template is positioned flush to the anterior tibial cortex. Place two Headless Pins in the anterior holes to secure the Universal Tibial Template.

Instrument Bar

6541-4-602

Universal Alignment Rods



6541-4-003

Headless Drill-Pins - 3"



6541-4-809

Headless Pin Driver



6541-4-801

Universal Driver



3170-0000

1/8" Drill



Triathlon® Knee System

Surgical Protocol



Figure 53

- ▶ If additional fixation is required after either Option 1 or 2 is used, place up to four Headed Nails in the holes on the Universal Tibial Template into the tibial plateau.
- ▶ Trials may be reassembled to the pinned template for any subsequent trial reductions.



Figure 54

Tibial Keel Punching

- ▶ Assemble the Keel Punch Guide to the Universal Tibial Template by inserting at a slight angle to the top of the Universal Tibial Template (into the two locating slots toward the posterior portion of the Universal Tibial Template). Allow the Keel Punch Guide to sit flat on the Universal Tibial Template and push forward on the handle to lock the Keel Punch Guide to the Universal Tibial Template (See Assembly 8).



Figure 55

- ▶ Place the appropriate Keel Punch into the Keel Punch Guide. Use a mallet to impact the Keel Punch. Advance the Keel Punch until it seats fully in the Keel Punch Guide.



Figure 56

- ▶ To extract the Keel Punch, lift up on the Keel Punch Guide handle and pull the handle to cantilever the Keel Punch out of the tibia.
- ▶ Remove the Headless Pins with the Headless Pin Extractor and remove the Universal Tibial Template.

Instrument Bar

6541-4-515

Headed Nails - 1 1/2"



6541-4-575

Headed Nails - 3/4"



Size 1, 2, 3 - **6541-2-713**

Size 4, 5, 6, 7, 8 - **6541-2-748**

Keel Punch Guide



Sizes 1, 2, 3 - **6541-2-013**

Sizes 4, 5, 6 - **6541-2-046**

Sizes 7, 8 - **6541-2-078**

Keel Punch



6541-4-804

Headless Pin Extractor



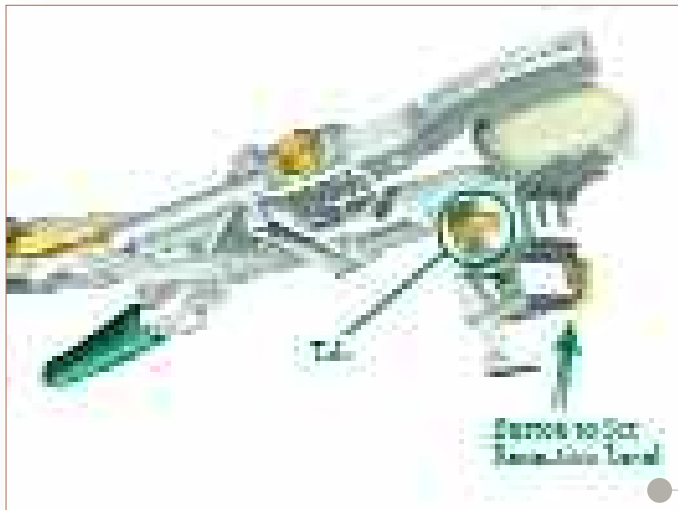

Figure 59

Option 2 – Bone Remaining Method

- ▶ Assemble Patella Clamp Jaws to the Patella Clamp. Attach the Patella Stylus to the hex shaped hole on the bottom side of either jaw by squeezing the gold tab (See Assembly 9).
- ▶ The Patella Stylus locks in a position that will ensure the referencing prongs are pointed toward the clamping area.
- ▶ The Patella Stylus determines how much bone will remain.
- ▶ Set the desired resection amount on the Patella Stylus by pressing the gold button and moving the body of the Patella Stylus to the resection line.
- ▶ Close the Patella Clamp around the patella.

Note: The resection level should not be set at a value less than 12mm.

Instrument Bar

6541-3-602
Patella Caliper



6541-3-702
Small Patella Clamp Jaw Right



6541-3-703
Small Patella Clamp Jaw Left



6541-3-704
Large Patella Clamp Jaw Right



6541-3-705
Large Patella Clamp Jaw Left



6541-3-600
Patella Clamp



6541-3-601
Patella Stylus



Triathlon® Knee System

Surgical Protocol



Figure 60

- ▶ Ensure that the Patella Stylus is touching the desired point(s) on the patella tendon.
- ▶ Make resection through one of the resection slots.

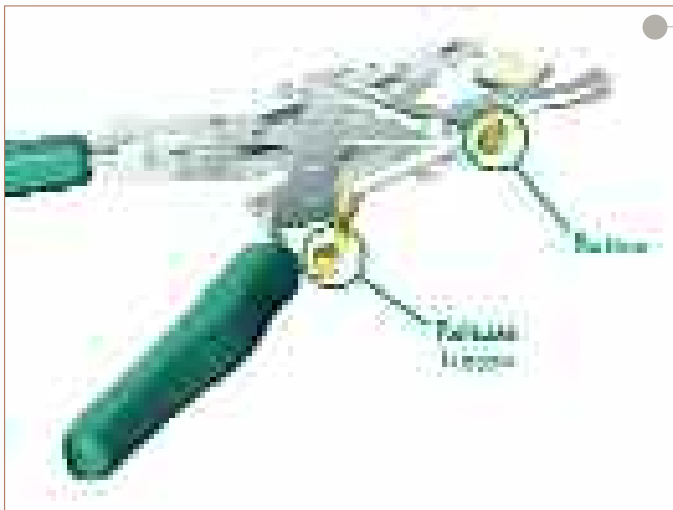

Figure 61

(The following applies to both Bone Removing Method and Bone Remaining Method)

- ▶ Disengage the Patella Clamp by pressing the gold release trigger.
- ▶ Press the gold buttons on the Patella Clamp to remove the Patella Clamp Jaws.

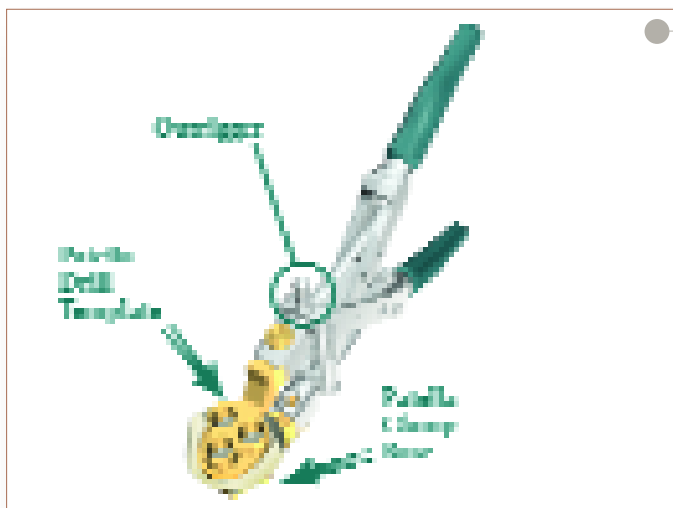

Figure 62

- ▶ Assess the size of the patella with a Patella Drill Template (Symmetric and Asymmetric are available).
- ▶ Assemble the desired Patella Drill Template and the Patella Clamp Base to the Patella Clamp. These are inserted in the same fashion as the Patella Clamp Jaws (See Assembly 9). Assemble the Patella Clamp Base first with the Patella Clamp's outrigger pointing superiorly.
- ▶ Close the Patella Clamp around the patella so that the Patella Clamp Base is touching the patella tendon and the base of the Patella Drill Template is touching the resected surface of the patella. Align the Patella Drill Template so that it is horizontal with respect to the poles of the patella.

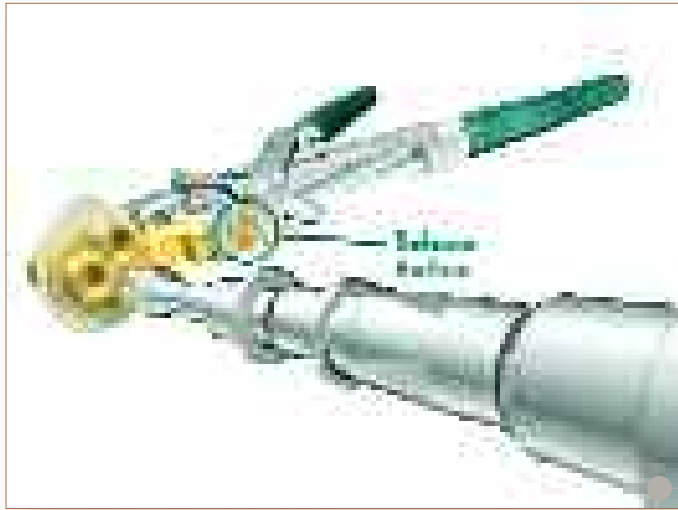

Figure 63

- ▶ Attach the All Poly Patella Drill with Stop to the Universal Driver and drill through each fixation peg hole of the Patella Drill Template.
- ▶ Disengage the Patella Clamp by pressing the release trigger. Press the gold buttons on the Patella Clamp to remove the Patella Template.



Figure 64

Patella Trial Assessment

- ▶ Remove any residual cartilage and wash away all debris. Place correct size Patella Trial (Symmetric or Asymmetric) onto the prepared patella.
- ▶ Replace all Trials and assess patellar tracking by taking the knee through a ROM. The patella should track normally throughout the ROM without tendency for tilting or lateral subluxation.

Instrument Bar

29mm - **6541-3-617**

32mm - **6541-3-618**

35mm - **6541-3-619**

38mm - **6541-3-620**

40mm - **6541-3-621**



Asymmetric Patella Drill Template

27mm - **6541-3-627**

29mm - **6541-3-629**

31mm - **6541-3-631**

33mm - **6541-3-633**

36mm - **6541-3-636**

39mm - **6541-3-639**



Symmetric Patella Drill Template

6541-3-801

Patella Clamp Base



6541-3-600

Patella Clamp



6541-3-524

All-Poly Patella Drill w/Stop



6541-4-801

Universal Driver



See Catalog

Symmetric Patella Trial



See Catalog

Asymmetric Patella Trial



Triathlon® Knee System

Surgical Protocol



Figure 65

Component Implantation

(All components are for use only with bone cement)

- ▶ If needed, prepare the resected bone surfaces using the Bone File, which is attached to the Impaction Handle.



Figure 66

PS or CR Femoral Component - Cemented

- ▶ Attach the Femoral Impactor Extractor to the Impaction Handle and attach to the appropriate size and side Femoral Component (**See Assembly 5**). Place the Femoral Component on the femur and impact it until fully seated.
 - Posterior Stabilized Knee: If Modular Femoral Distal Fixation Pegs are to be used, assemble the pegs to the Femoral Component using the 1/8" Hex Drive and the Slip Torque Handle prior to implantation (**See Assembly 10**).



Figure 67

- ▶ The Femoral Impactor can be attached to the Impaction Handle to further seat the Femoral Component onto the prepared femur.

Note: Clear all excess bone cement.



Figure 68

Primary Tibial Baseplate - Cemented

- ▶ Connect the Tibial Baseplate Impactor Extractor to the Impaction Handle. To connect this assembly to the Primary Tibial Baseplate, ensure the locking lever is in the unlocked position and place the head onto the Primary Tibial Baseplate straddling the central island. Ensure the Tibial Baseplate Impactor Extractor sits flat on the top surface of the Primary Tibial Baseplate and move the locking lever to the locked position.
- ▶ Introduce the Primary Tibial Baseplate onto the prepared tibia and impact until the baseplate is seated. Unlock the locking lever and remove the assembly from the Primary Tibial Baseplate.

Instrument Bar

6541-4-700

Bone File



6541-4-807

Femoral Impactor Extractor



6541-4-810

Impaction Handle



See Catalog

PS Femoral Component - Cemented



See Catalog

CR Femoral Component - Cemented



6541-4-802

1/8" Hex Drive



6541-4-825

Slip Torque Handle



See Catalog

Modular Femoral Distal Fixation Pegs



6541-4-811

Femoral Impactor



6541-4-805

Baseplate Impactor/Extractor



See Catalog

Primary Tibial Baseplate - Cemented



Triathlon® Knee System

Surgical Protocol



Figure 69

- ▶ To further seat the baseplate, attach the Tibial Baseplate Impactor to the Impaction Handle.
- ▶ Place the Tibial Baseplate Impactor on to the Primary Tibial Baseplate straddling the central island. Ensure the Tibial Baseplate Impactor sits flat on the top surface of the Primary Tibial Baseplate.
- ▶ Impact until the Primary Tibial Baseplate is fully seated.

Note: Clear all excess bone cement while maintaining position of the Primary Tibial Baseplate.

PS or CR Tibial Insert

- ▶ Prior to assembly of the PS or CR Tibial Insert, the PS or CR Tibial Trial Insert may be placed on the Primary Tibial Baseplate to once more assess joint stability and range of motion.
- ▶ To assemble the PS or CR Tibial Insert, distract the joint and angle the insert posteriorly into the Primary Tibial Baseplate. The posterior lip of the Tibial Insert must fit beneath the lip on the posterior Primary Tibial Baseplate wall.
- ▶ Attach the Tibial Insert Impactor to the Impaction Handle and impact to snap the Insert in place anteriorly. The PS or CR Tibial Insert is fully seated once the locking wire locks under the barbs on the anterior/interior surface of the Primary Tibial Baseplate wall.



Figure 70

Symmetric or Asymmetric Patella

- ▶ Assemble the Patella Cement Cap and the Patella Clamp Base to the Patella Clamp (See Assembly 9).
- Note:** If necessary, use a curette to mark the locations of the fixation peg holes.
- ▶ Place the Patella Component onto the prepared patella, making certain the fixation peg holes are aligned to the corresponding holes.

- ▶ Seat the Patella Component onto the prepared patella by clamping the Patella Cement Cap, Patella Clamp Base and Patella Clamp assembly.

Note: Insure that the silicon o-ring of the Patella Cement Cap is placed on the articulating surface of the Patella Component.

Note: Leave the assembly clamped to the patella while excess cement is cleared and polymerization is complete.

- ▶ Disengage the Patella Clamp by pressing the gold release trigger.

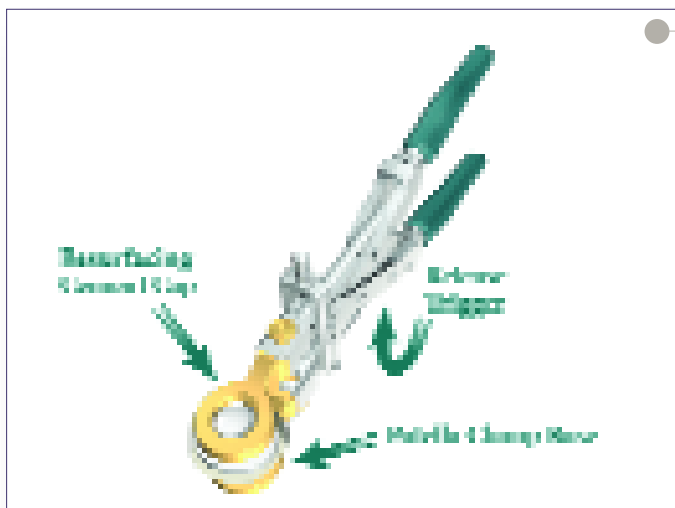

Figure 71



Figure 72

- ▶ Assess the joint in flexion and extension.

Closure

- ▶ After cement polymerization and removal of all residual cement, thoroughly irrigate the joint. Hemostasis is achieved after deflation of the tourniquet. Close soft tissues in the normal layered fashion.

Instrument Bar

6541-4-810

Impaction Handle



6541-4-812

Tibial Baseplate Impactor



6541-4-813

Tibial Insert Impactor



See Catalog

PS Tibial Insert



See Catalog

CR Tibial Insert



6541-3-800

Patella Cement Cap



6541-3-801

Patella Clamp Base



6541-3-600

Patella Clamp



See Catalog

Symmetric Patella



See Catalog

Asymmetric Patella



Triathlon® Knee System

Surgical Protocol

Catalog #	Description	Quantity in Kit
Miscellaneous Instruments Kit Contents		
3170-0000	1/8" Drill	2
6541-4-003	Headless Pins - 3"	4
6541-4-300	Headed Nail Impactor Extractor	1
6541-4-400	Bladerunner	1
6541-4-515	Headed Nails - 1 1/2"	2
6541-4-516	5/16" IM Rod	1
6541-4-518	1/8" Peg Drill	1
6541-4-525	1/4" Peg Drill	1
6541-4-538	3/8" IM Drill	1
6541-4-575	Headed Nails - 3/4"	2
6541-4-602	Universal Alignment Rods	2
6541-4-610	Adjustable Spacer Block	1
6541-4-700	Bone File	1
6541-4-709	Box Chisel	1
6541-4-710	Posterior osteophyte removal tool	1
6541-4-800	T-Handle Driver	1
6541-4-801	Universal Driver	1
6541-4-802	1/8" Hex Drive	1
6541-4-803	Slap Hammer	1
6541-4-804	Headless Pin Extractor	1
6541-4-805	Tibial Baseplate Impactor Extractor	1
6541-4-806	Universal Alignment Handle	1
6541-4-807	Femoral Impactor Extractor	1
6541-4-808	Modular Handle	2
6541-4-809	Headless Pin Driver	1
6541-4-810	Impaction Handle	2
6541-4-811	Femoral Impactor	1
6541-4-812	Tibial Baseplate Impactor	1
6541-4-813	Tibial Insert Impactor	1
6541-4-825	Slip Torque Handle	1
6541-8-004	Triathlon Miscellaneous Upper Tray	1
6541-8-104	Triathlon Miscellaneous Lower Tray	1
6541-9-000	Triathlon Case	1
		Total Quantity 42

Catalog #	Description	Quantity in Kit
Patella Preparation & Trialing Kit Contents		
5550-T-278	Symmetric Patella Trial S27mm x 8mm	1
5550-T-298	Symmetric Patella Trial S29mm x 8mm	1
5550-T-319	Symmetric Patella Trial S31mm x 9mm	1
5550-T-339	Symmetric Patella Trial S33mm x 9mm	1
5550-T-360	Symmetric Patella Trial S36mm x 10mm	1
5550-T-391	Symmetric Patella Trial S39mm x 11mm	1
5551-T-299	Asymmetric Patella Trial A29mm (S/I*) x 9mm	1
5551-T-320	Asymmetric Patella Trial A32mm (S/I*) x 10mm	1
5551-T-350	Asymmetric Patella Trial A35mm (S/I*) x 10mm	1
5551-T-381	Asymmetric Patella Trial A38mm (S/I*) x 11mm	1
5551-T-401	Asymmetric Patella Trial A40mm (S/I*) x 11mm	1
6541-3-524	All Poly Patella Drill w/ Stop	1
6541-3-600	Patella Clamp	1
6541-3-601	Patella Stylus	1
6541-3-602	Patella Caliper	1
6541-3-617	Asymmetric Patella Drill Template - A29mm	1
6541-3-618	Asymmetric Patella Drill Template - A32mm	1
6541-3-619	Asymmetric Patella Drill Template - A35mm	1
6541-3-620	Asymmetric Patella Drill Template - A38mm	1
6541-3-621	Asymmetric Patella Drill Template - A40mm	1
6541-3-627	Symmetric Patella Drill Template - S27mm	1
6541-3-629	Symmetric Patella Drill Template - S29mm	1
6541-3-631	Symmetric Patella Drill Template - S31mm	1
6541-3-633	Symmetric Patella Drill Template - S33mm	1
6541-3-636	Symmetric Patella Drill Template - S36mm	1
6541-3-639	Symmetric Patella Drill Template - S39mm	1
6541-3-702	Small Patella Clamp Jaw Right	1
6541-3-703	Small Patella Clamp Jaw Left	1
6541-3-704	Large Patella Clamp Jaw Right	1
6541-3-705	Large Patella Clamp Jaw Left	1
6541-3-800	Patella Cement Cap	1
6541-3-801	Patella Clamp Base	1
8050-5001L	Left Lateral Tibial Retractor	1
8050-5001R	Right Lateral Tibial Retractor	1
8050-5002	Anterior Femoral Retractor	1
6541-8-005	Triathlon Patella Upper Tray	1
6541-8-105	Triathlon Patella Lower Tray	1
6541-9-000	Triathlon Case	1
Total Quantity		38

*S/I = Superior/Inferior

Triathlon® Knee System

Surgical Protocol

Catalog #	Description	Quantity in Kit
Size 3-6 Femoral & Tibial Preparation Kit Contents		
6541-1-600	Adjustment Block	1
6541-1-603	Femoral Sizer	1
6541-1-605	Femoral Stylus	1
6541-1-657	Femoral Alignment Guide	1
6541-1-703	#3 4:1 Cutting Block	1
6541-1-704	#4 4:1 Cutting Block	1
6541-1-705	#5 4:1 Cutting Block	1
6541-1-706	#6 4:1 Cutting Block	1
6541-1-721	Distal Resection Guide	1
6541-1-723	Modular Capture - Distal Resection	1
6541-1-805	4:1 Strike Plate	1
6541-1-806	4:1 Modular Capture	2
6541-2-013	Size 1-3 Keel Punch	1
6541-2-046	Size 4-6 Keel Punch	1
6541-2-429	Tibial Stylus	1
6541-2-600	Tibial Alignment Jig IM	1
6541-2-603	#3 Universal Tibial Template	1
6541-2-604	#4 Universal Tibial Template	1
6541-2-605	#5 Universal Tibial Template	1
6541-2-606	#6 Universal Tibial Template	1
6541-2-609	Tibial Alignment Ankle Clamp EM	1
6541-2-610	Tibial Alignment Distal Assembly EM	1
6541-2-611	Tibial Alignment Proximal Rod EM	1
6541-2-620	Tibial Template Converter	1
6541-2-700	Tibial Resection Guide Right	1
6541-2-701	Tibial Resection Guide Left	1
6541-2-702	Tibial Resection Guide Modular Capture Right	1
6541-2-703	Tibial Resection Guide Modular Capture Left	1
6541-2-704	Tibial Adjustment Housing - 0° slope	1
6541-2-705	Tibial Adjustment Housing - 3° slope	1
6541-2-713	Size 1-3 Keel Punch Guide	1
6541-2-748	Size 4-8 Keel Punch Guide	1
6541-2-807	Tibial Alignment Handle	1
6541-8-002	Triathlon Size 3-6 Upper Tray	1
6541-8-102	Triathlon Size 3-6 Lower Tray	1
6541-9-000	Triathlon Case	1
Total Quantity		37

Catalog #	Description	Quantity in Kit
-----------	-------------	-----------------

Size 3-6 PS Femoral & Tibial Trialing Kit Contents

5511-T-301	PS Femoral Trial # 3 Left	1
5511-T-302	PS Femoral Trial # 3 Right	1
5511-T-401	PS Femoral Trial # 4 Left	1
5511-T-402	PS Femoral Trial # 4 Right	1
5511-T-501	PS Femoral Trial # 5 Left	1
5511-T-502	PS Femoral Trial # 5 Right	1
5511-T-601	PS Femoral Trial # 6 Left	1
5511-T-602	PS Femoral Trial # 6 Right	1
5532-T-309	PS Tibial Insert Trial # 3 - 9mm	1
5532-T-311	PS Tibial Insert Trial # 3 - 11mm	1
5532-T-313	PS Tibial Insert Trial # 3 - 13mm	1
5532-T-316	PS Tibial Insert Trial # 3 - 16mm	1
5532-T-319	PS Tibial Insert Trial # 3 - 19mm	1
5532-T-409	PS Tibial Insert Trial # 4 - 9mm	1
5532-T-411	PS Tibial Insert Trial # 4 - 11mm	1
5532-T-413	PS Tibial Insert Trial # 4 - 13mm	1
5532-T-416	PS Tibial Insert Trial # 4 - 16mm	1
5532-T-419	PS Tibial Insert Trial # 4 - 19mm	1
5532-T-509	PS Tibial Insert Trial # 5 - 9mm	1
5532-T-511	PS Tibial Insert Trial # 5 - 11mm	1
5532-T-513	PS Tibial Insert Trial # 5 - 13mm	1
5532-T-516	PS Tibial Insert Trial # 5 - 16mm	1
5532-T-519	PS Tibial Insert Trial # 5 - 19mm	1
5532-T-609	PS Tibial Insert Trial # 6 - 9mm	1
5532-T-611	PS Tibial Insert Trial # 6 - 11mm	1
5532-T-613	PS Tibial Insert Trial # 6 - 13mm	1
5532-T-616	PS Tibial Insert Trial # 6 - 16mm	1
5532-T-619	PS Tibial Insert Trial # 6 - 19mm	1
6541-1-713	#3 PS Box Cutting Guide	1
6541-1-714	#4 PS Box Cutting Guide	1
6541-1-715	#5 PS Box Cutting Guide	1
6541-1-716	#6 PS Box Cutting Guide	1
6541-8-009	Triathlon 3-6 PS Upper Tray	1
6541-8-109	Triathlon 3-6 PS Lower Tray	1
6541-9-000	Triathlon Case	1

Total Quantity 35

*S/I = Superior/Inferior

Triathlon® Knee System

Surgical Protocol

Catalog #	Description	Quantity in Kit
Size 3-6 CR Femoral & Tibial Trialing Kit Contents		
5510-T-301	CR Femoral Trial # 3 Left	1
5510-T-302	CR Femoral Trial # 3 Right	1
5510-T-401	CR Femoral Trial # 4 Left	1
5510-T-402	CR Femoral Trial # 4 Right	1
5510-T-501	CR Femoral Trial # 5 Left	1
5510-T-502	CR Femoral Trial # 5 Right	1
5510-T-601	CR Femoral Trial # 6 Left	1
5510-T-602	CR Femoral Trial # 6 Right	1
5530-T-309	CR Tibial Insert Trial # 3 - 9mm	1
5530-T-311	CR Tibial Insert Trial # 3 - 11mm	1
5530-T-313	CR Tibial Insert Trial # 3 - 13mm	1
5530-T-316	CR Tibial Insert Trial # 3 - 16mm	1
5530-T-319	CR Tibial Insert Trial # 3 - 19mm	1
5530-T-409	CR Tibial Insert Trial # 4 - 9mm	1
5530-T-411	CR Tibial Insert Trial # 4 - 11mm	1
5530-T-413	CR Tibial Insert Trial # 4 - 13mm	1
5530-T-416	CR Tibial Insert Trial # 4 - 16mm	1
5530-T-419	CR Tibial Insert Trial # 4 - 19mm	1
5530-T-509	CR Tibial Insert Trial # 5 - 9mm	1
5530-T-511	CR Tibial Insert Trial # 5 - 11mm	1
5530-T-513	CR Tibial Insert Trial # 5 - 13mm	1
5530-T-516	CR Tibial Insert Trial # 5 - 16mm	1
5530-T-519	CR Tibial Insert Trial # 5 - 19mm	1
5530-T-609	CR Tibial Insert Trial # 6 - 9mm	1
5530-T-611	CR Tibial Insert Trial # 6 - 11mm	1
5530-T-613	CR Tibial Insert Trial # 6 - 13mm	1
5530-T-616	CR Tibial Insert Trial # 6 - 16mm	1
5530-T-619	CR Tibial Insert Trial # 6 - 19mm	1
6541-8-008	Triathlon 3-6 CR Upper Tray	1
6541-8-108	Triathlon 3-6 CR Lower Tray	1
6541-9-000	Triathlon Case	1
		Total Quantity 31

Catalog #	Description	Quantity in Kit
-----------	-------------	-----------------

Size 1, 8 PS Preparation & Trialing Kit Contents

5511-T-101	PS Femoral Trial # 1 Left	1
5511-T-102	PS Femoral Trial # 1 Right	1
5511-T-801	PS Femoral Trial # 8 Left	1
5511-T-802	PS Femoral Trial # 8 Right	1
5532-T-109	PS Tibial Insert Trial # 1 - 9mm	1
5532-T-111	PS Tibial Insert Trial # 1 - 11mm	1
5532-T-113	PS Tibial Insert Trial # 1 - 13mm	1
5532-T-116	PS Tibial Insert Trial # 1 - 16mm	1
5532-T-119	PS Tibial Insert Trial # 1 - 19mm	1
5532-T-809	PS Tibial Insert Trial # 8 - 9mm	1
5532-T-811	PS Tibial Insert Trial # 8 - 11mm	1
5532-T-813	PS Tibial Insert Trial # 8 - 13mm	1
5532-T-816	PS Tibial Insert Trial # 8 - 16mm	1
5532-T-819	PS Tibial Insert Trial # 8 - 19mm	1
6541-1-701	#1 4:1 Cutting Block	1
6541-1-708	#8 4:1 Cutting Block	1
6541-1-711	#1 PS Box Cutting Guide	1
6541-1-718	#8 PS Box Cutting Guide	1
6541-2-078	Size 7-8 Keel Punch	1
6541-2-601	#1 Universal Tibial Template	1
6541-2-608	#8 Universal Tibial Template	1
6541-8-113	Triathlon 1 & 8 PS Lower Tray	1
6541-9-000	Triathlon Case	1

Total Quantity 23

Triathlon® Knee System

Surgical Protocol

Catalog #	Description	Quantity in Kit
Size 1, 8 CR Preparation & Trialing Kit Contents		
5510-T-101	CR Femoral Trial # 1 Left	1
5510-T-102	CR Femoral Trial # 1 Right	1
5510-T-801	CR Femoral Trial # 8 Left	1
5510-T-802	CR Femoral Trial # 8 Right	1
5530-T-109	CR Tibial Insert Trial # 1 - 9mm	1
5530-T-111	CR Tibial Insert Trial # 1 - 11mm	1
5530-T-113	CR Tibial Insert Trial # 1 - 13mm	1
5530-T-116	CR Tibial Insert Trial # 1 - 16mm	1
5530-T-119	CR Tibial Insert Trial # 1 - 19mm	1
5530-T-809	CR Tibial Insert Trial # 8 - 9mm	1
5530-T-811	CR Tibial Insert Trial # 8 - 11mm	1
5530-T-813	CR Tibial Insert Trial # 8 - 13mm	1
5530-T-816	CR Tibial Insert Trial # 8 - 16mm	1
5530-T-819	CR Tibial Insert Trial # 8 - 19mm	1
6541-1-701	#1 4:1 Cutting Block	1
6541-1-708	#8 4:1 Cutting Block	1
6541-2-078	Size 7-8 Keel Punch	1
6541-2-601	#1 Universal Tibial Template	1
6541-2-608	#8 Universal Tibial Template	1
6541-8-112	Triathlon 1 & 8 CR Lower Tray	1
6541-9-000	Triathlon Case	1
		Total Quantity 21

Size 2, 7 PS Preparation & Trialing Kit Contents

5511-T-201	PS Femoral Trial # 2 Left	1
5511-T-202	PS Femoral Trial # 2 Right	1
5511-T-701	PS Femoral Trial # 7 Left	1
5511-T-702	PS Femoral Trial # 7 Right	1
5532-T-209	PS Tibial Insert Trial # 2 - 9mm	1
5532-T-211	PS Tibial Insert Trial # 2 - 11mm	1
5532-T-213	PS Tibial Insert Trial # 2 - 13mm	1
5532-T-216	PS Tibial Insert Trial # 2 - 16mm	1
5532-T-219	PS Tibial Insert Trial # 2 - 19mm	1
5532-T-709	PS Tibial Insert Trial # 7 - 9mm	1
5532-T-711	PS Tibial Insert Trial # 7 - 11mm	1
5532-T-713	PS Tibial Insert Trial # 7 - 13mm	1
5532-T-716	PS Tibial Insert Trial # 7 - 16mm	1
5532-T-719	PS Tibial Insert Trial # 7 - 19mm	1
6541-1-702	#2 4:1 Cutting Block	1
6541-1-707	#7 4:1 Cutting Block	1
6541-1-712	#2 PS Box Cutting Guide	1
6541-1-717	#7 PS Box Cutting Guide	1
6541-2-078	Size 7-8 Keel Punch	1
6541-2-602	#2 Universal Tibial Template	1
6541-2-607	#7 Universal Tibial Template	1
6541-8-022	Triathlon 2 & 7 PS Upper Tray	1
6541-9-000	Triathlon Case	1
		Total Quantity 23

Catalog #	Description	Quantity in Kit
-----------	-------------	-----------------

Size 2, 7 CR Preparation & Trialing Kit Contents

5510-T-201	CR Femoral Trial # 2 Left	1
5510-T-202	CR Femoral Trial # 2 Right	1
5510-T-701	CR Femoral Trial # 7 Left	1
5510-T-702	CR Femoral Trial # 7 Right	1
5530-T-209	CR Tibial Insert Trial # 2 - 9mm	1
5530-T-211	CR Tibial Insert Trial # 2 - 11mm	1
5530-T-213	CR Tibial Insert Trial # 2 - 13mm	1
5530-T-216	CR Tibial Insert Trial # 2 - 16mm	1
5530-T-219	CR Tibial Insert Trial # 2 - 19mm	1
5530-T-709	CR Tibial Insert Trial # 7 - 9mm	1
5530-T-711	CR Tibial Insert Trial # 7 - 11mm	1
5530-T-713	CR Tibial Insert Trial # 7 - 13mm	1
5530-T-716	CR Tibial Insert Trial # 7 - 16mm	1
5530-T-719	CR Tibial Insert Trial # 7 - 19mm	1
6541-1-702	#2 4:1 Cutting Block	1
6541-1-707	#7 4:1 Cutting Block	1
6541-2-078	Size 7-8 Keel Punch	1
6541-2-602	#2 Universal Tibial Template	1
6541-2-607	#7 Universal Tibial Template	1
6541-8-021	Triathlon 2 & 7 CR Upper Tray	1
6541-9-000	Triathlon Case	1

Total Quantity 21

Size 1-8 Max PS Tibial Trialing Kit Contents

5532-T-122	PS Tibial Insert Trial # 1 - 22mm	1
5532-T-125	PS Tibial Insert Trial # 1 - 25mm	1
5532-T-222	PS Tibial Insert Trial # 2 - 22mm	1
5532-T-225	PS Tibial Insert Trial # 2 - 25mm	1
5532-T-322	PS Tibial Insert Trial # 3 - 22mm	1
5532-T-325	PS Tibial Insert Trial # 3 - 25mm	1
5532-T-422	PS Tibial Insert Trial # 4 - 22mm	1
5532-T-425	PS Tibial Insert Trial # 4 - 25mm	1
5532-T-522	PS Tibial Insert Trial # 5 - 22mm	1
5532-T-525	PS Tibial Insert Trial # 5 - 25mm	1
5532-T-622	PS Tibial Insert Trial # 6 - 22mm	1
5532-T-625	PS Tibial Insert Trial # 6 - 25mm	1
5532-T-722	PS Tibial Insert Trial # 7 - 22mm	1
5532-T-725	PS Tibial Insert Trial # 7 - 25mm	1
5532-T-822	PS Tibial Insert Trial # 8 - 22mm	1
5532-T-825	PS Tibial Insert Trial # 8 - 25mm	1
6541-8-020	Triathlon Max PS Tibial Trialing Upper Tray	1
6541-8-120	Triathlon Max PS Tibial Trialing Lower Tray	1
6541-9-000	Triathlon Case	1

Total Quantity 19

Triathlon® Knee System

Surgical Protocol

Catalog #	Description
PS Femoral Component - Cemented Part Numbers	
5515-F-101	PS Femoral Component – Cemented #1 Left
5515-F-102	PS Femoral Component – Cemented #1 Right
5515-F-201	PS Femoral Component – Cemented #2 Left
5515-F-202	PS Femoral Component – Cemented #2 Right
5515-F-301	PS Femoral Component – Cemented #3 Left
5515-F-302	PS Femoral Component – Cemented #3 Right
5515-F-401	PS Femoral Component – Cemented #4 Left
5515-F-402	PS Femoral Component – Cemented #4 Right
5515-F-501	PS Femoral Component – Cemented #5 Left
5515-F-502	PS Femoral Component – Cemented #5 Right
5515-F-601	PS Femoral Component – Cemented #6 Left
5515-F-602	PS Femoral Component – Cemented #6 Right
5515-F-701	PS Femoral Component – Cemented #7 Left
5515-F-702	PS Femoral Component – Cemented #7 Right
5515-F-801	PS Femoral Component – Cemented #8 Left
5515-F-802	PS Femoral Component – Cemented #8 Right
CR Femoral Component - Cemented Part Numbers	
5510-F-101	CR Femoral Component – Cemented #1 Left
5510-F-102	CR Femoral Component – Cemented #1 Right
5510-F-201	CR Femoral Component – Cemented #2 Left
5510-F-202	CR Femoral Component – Cemented #2 Right
5510-F-301	CR Femoral Component – Cemented #3 Left
5510-F-302	CR Femoral Component – Cemented #3 Right
5510-F-401	CR Femoral Component – Cemented #4 Left
5510-F-402	CR Femoral Component – Cemented #4 Right
5510-F-501	CR Femoral Component – Cemented #5 Left
5510-F-502	CR Femoral Component – Cemented #5 Right
5510-F-601	CR Femoral Component – Cemented #6 Left
5510-F-602	CR Femoral Component – Cemented #6 Right
5510-F-701	CR Femoral Component – Cemented #7 Left
5510-F-702	CR Femoral Component – Cemented #7 Right
5510-F-801	CR Femoral Component – Cemented #8 Left
5510-F-802	CR Femoral Component – Cemented #8 Right
Primary Tibial Baseplate - Cemented Part Numbers	
5520-B-100	Primary Tibial Baseplate – Cemented #1
5520-B-200	Primary Tibial Baseplate – Cemented #2
5520-B-300	Primary Tibial Baseplate – Cemented #3
5520-B-400	Primary Tibial Baseplate – Cemented #4
5520-B-500	Primary Tibial Baseplate – Cemented #5
5520-B-600	Primary Tibial Baseplate – Cemented #6
5520-B-700	Primary Tibial Baseplate – Cemented #7
5520-B-800	Primary Tibial Baseplate – Cemented #8

Catalog #	Description
-----------	-------------

PS Tibial Insert Part Numbers

5532-P-109*	PS Tibial Insert #1 – 9mm
5532-P-111*	PS Tibial Insert #1 – 11mm
5532-P-113*	PS Tibial Insert #1 – 13mm
5532-P-116*	PS Tibial Insert #1 – 16mm
5532-P-119*	PS Tibial Insert #1 – 19mm
5532-P-122*	PS Tibial Insert #1 – 22mm
5532-P-125*	PS Tibial Insert #1 – 25mm

5532-P-209	PS Tibial Insert #2 – 9mm
5532-P-211	PS Tibial Insert #2 – 11mm
5532-P-213	PS Tibial Insert #2 – 13mm
5532-P-216	PS Tibial Insert #2 – 16mm
5532-P-219	PS Tibial Insert #2 – 19mm
5532-P-222	PS Tibial Insert #2 – 22mm
5532-P-225	PS Tibial Insert #2 – 25mm

5532-P-309	PS Tibial Insert #3 – 9mm
5532-P-311	PS Tibial Insert #3 – 11mm
5532-P-313	PS Tibial Insert #3 – 13mm
5532-P-316	PS Tibial Insert #3 – 16mm
5532-P-319	PS Tibial Insert #3 – 19mm
5532-P-322	PS Tibial Insert #3 – 22mm
5532-P-325	PS Tibial Insert #3 – 25mm

5532-P-409	PS Tibial Insert #4 – 9mm
5532-P-411	PS Tibial Insert #4 – 11mm
5532-P-413	PS Tibial Insert #4 – 13mm
5532-P-416	PS Tibial Insert #4 – 16mm
5532-P-419	PS Tibial Insert #4 – 19mm
5532-P-422	PS Tibial Insert #4 – 22mm
5532-P-425	PS Tibial Insert #4 – 25mm

5532-P-509	PS Tibial Insert #5 – 9mm
5532-P-511	PS Tibial Insert #5 – 11mm
5532-P-513	PS Tibial Insert #5 – 13mm
5532-P-516	PS Tibial Insert #5 – 16mm
5532-P-519	PS Tibial Insert #5 – 19mm
5532-P-522	PS Tibial Insert #5 – 22mm
5532-P-525	PS Tibial Insert #5 – 25mm

5532-P-609	PS Tibial Insert #6 – 9mm
5532-P-611	PS Tibial Insert #6 – 11mm
5532-P-613	PS Tibial Insert #6 – 13mm
5532-P-616	PS Tibial Insert #6 – 16mm
5532-P-619	PS Tibial Insert #6 – 19mm
5532-P-622	PS Tibial Insert #6 – 22mm
5532-P-625	PS Tibial Insert #6 – 25mm

Continued

Note: 5532-P-109 through 5532-P-125 are not available for sale in the US.

Triathlon® Knee System

Surgical Protocol

Catalog #	Description
-----------	-------------

PS Tibial Insert Part Numbers - Continued

5532-P-709	PS Tibial Insert #7 – 9mm
5532-P-711	PS Tibial Insert #7 – 11mm
5532-P-713	PS Tibial Insert #7 – 13mm
5532-P-716	PS Tibial Insert #7 – 16mm
5532-P-719	PS Tibial Insert #7 – 19mm
5532-P-722	PS Tibial Insert #7 – 22mm
5532-P-725	PS Tibial Insert #7 – 25mm
5532-P-809	PS Tibial Insert #8 – 9mm
5532-P-811	PS Tibial Insert #8 – 11mm
5532-P-813	PS Tibial Insert #8 – 13mm
5532-P-816	PS Tibial Insert #8 – 16mm
5532-P-819	PS Tibial Insert #8 – 19mm
5532-P-822	PS Tibial Insert #8 – 22mm
5532-P-825	PS Tibial Insert #8 – 25mm

CR Tibial Insert Part Numbers

5530-P-109	CR Tibial Insert #1 – 9mm
5530-P-111	CR Tibial Insert #1 – 11mm
5530-P-113	CR Tibial Insert #1 – 13mm
5530-P-116	CR Tibial Insert #1 – 16mm
5530-P-119	CR Tibial Insert #1 – 19mm
5530-P-209	CR Tibial Insert #2 – 9mm
5530-P-211	CR Tibial Insert #2 – 11mm
5530-P-213	CR Tibial Insert #2 – 13mm
5530-P-216	CR Tibial Insert #2 – 16mm
5530-P-219	CR Tibial Insert #2 – 19mm
5530-P-309	CR Tibial Insert #3 – 9mm
5530-P-311	CR Tibial Insert #3 – 11mm
5530-P-313	CR Tibial Insert #3 – 13mm
5530-P-316	CR Tibial Insert #3 – 16mm
5530-P-319	CR Tibial Insert #3 – 19mm
5530-P-409	CR Tibial Insert #4 – 9mm
5530-P-411	CR Tibial Insert #4 – 11mm
5530-P-413	CR Tibial Insert #4 – 13mm
5530-P-416	CR Tibial Insert #4 – 16mm
5530-P-419	CR Tibial Insert #4 – 19mm
5530-P-509	CR Tibial Insert #5 – 9mm
5530-P-511	CR Tibial Insert #5 – 11mm
5530-P-513	CR Tibial Insert #5 – 13mm
5530-P-516	CR Tibial Insert #5 – 16mm
5530-P-519	CR Tibial Insert #5 – 19mm

Catalog #	Description
-----------	-------------

CR Tibial Insert Part Numbers - Continued

5530-P-609	CR Tibial Insert #6 – 9mm
5530-P-611	CR Tibial Insert #6 – 11mm
5530-P-613	CR Tibial Insert #6 – 13mm
5530-P-616	CR Tibial Insert #6 – 16mm
5530-P-619	CR Tibial Insert #6 – 19mm
5530-P-709	CR Tibial Insert #7 – 9mm
5530-P-711	CR Tibial Insert #7 – 11mm
5530-P-713	CR Tibial Insert #7 – 13mm
5530-P-716	CR Tibial Insert #7 – 16mm
5530-P-719	CR Tibial Insert #7 – 19mm
5530-P-809	CR Tibial Insert #8 – 9mm
5530-P-811	CR Tibial Insert #8 – 11mm
5530-P-813	CR Tibial Insert #8 – 13mm
5530-P-816	CR Tibial Insert #8 – 16mm
5530-P-819	CR Tibial Insert #8 – 19mm

Symmetric Patella Part Numbers

5550-L-278	Symmetric Patella S27mm x 8mm
5550-L-298	Symmetric Patella S29mm x 8mm
5550-L-319	Symmetric Patella S31mm x 9mm
5550-L-339	Symmetric Patella S33mm x 9mm
5550-L-360	Symmetric Patella S36mm x 10mm
5550-L-391	Symmetric Patella S39mm x 11mm

Asymmetric Patella Part Numbers

5551-L-299	Asymmetric Patella A29mm (S/I*) x 9mm
5551-L-320	Asymmetric Patella A32mm (S/I*) x 10mm
5551-L-350	Asymmetric Patella A35mm (S/I*) x 10mm
5551-L-381	Asymmetric Patella A38mm (S/I*) x 11mm
5551-L-401	Asymmetric Patella A40mm (S/I*) x 11mm

* S/I = Superior/Inferior

Modular Femoral Distal Fixation Peg Part Number

5575-X-000	Modular Femoral Distal Fixation Peg (2 per pack)
------------	--

Joint Replacements

Trauma

Spine

Micro Implants

Orthobiologics

Instruments

Interventional Pain

Navigation

Endoscopy

Communications

Patient Handling Equipment

EMS Equipment

325 Corporate Drive
Mahwah, New Jersey 07430
t: 201 831 5000

www.stryker.com

Triathlon[®] Knee System is marketed in the United States for use with bone cement.

A surgeon must always rely on his or her own professional clinical judgment when deciding to use which products and/or techniques on individual patients. Stryker is not dispensing medical advice and recommends that surgeons be trained in knee implant surgeries before performing any knee surgeries.

The information presented in this brochure is intended to demonstrate the breadth of Stryker product offerings. Always refer to the package insert, product label and/or user instructions before using any Stryker product. Products may not be available in all markets. Product availability is subject to the regulatory or medical practices that govern individual markets. Please contact your Stryker representative if you have questions about the availability of Stryker products in your area.

Products referenced with [™] designation are trademarks of Stryker[®].
Products referenced with [®] designation are registered trademarks of Stryker[®].

Literature Number: **LSPK42**
GC/GS 3.8m 5/05

Copyright © 2005 Stryker[®]
Printed in USA